

Merika® - tuoteluettelo

Nro 25



Quality for HVAC
Technology



Sisältö

Merika[®]-tuoteluettelo Nro 25

Quality for HVAC
Technology



Tuoteryhmä	Sivu
Myynti- ja takuehdot	3
Yhteystiedot	4
1 Alipaineventtiilit	6
2 Ilmastuslaitteet	8
3 Lattiakaivot ja korotusrenkaat.	11
4 Hiekanerotuskaivot ja korotusrenkaat.	21
5 Öljynerotuskaivot.	27
6 Peitelaatat	31
7 Hanakulmat ja viemäröintiosat	34
8 Suihkuletkut, poisto- ja tuloletkut	40
9 Neliökannet	43
10 Vesilukkoputken tiivisteet	53
11 Vesilukot ja tarvikkeet	57
12 WC-liitosyhteet ja tarvikkeet	63
13 Työtulpat	67
14 Putkipitimet muovia	70
15 Sadevesikaivot ja salaojakaivot	74
16 PP-osat ja putket	83
17 PVC-osat	96
18 Hanakulmarasiat ja tarvikkeet	101
19 Uimuriventtiilit ja WC-varaosat	115
20 Kunnallistekniset tarvikkeet	120
21 Kansistot	126
22 Mainostuotteet.	130
23 Sähkötarvikkeet	134
24 Kuljetusboxit	136
25 HD-osat	137
26 Reimarit	139
27 Muut tuotteet.	140
Poistoputkien korkeudet ja virtaamat Merika-kaivoissa	143
Tuotehakemisto	144

Myynti- ja takuuehdot

Quality for HVAC
Technology



Toimitus- ja myyntiehdot

- Tuotteiden hinnat ovat voimassa olevan hinnastomme tai myyjän antaman erillisen tarjouksen mukaisia verottomia hintoja. Hintoihin lisätään kulloinkin voimassa oleva arvonlisävero.
- Lähetys tapahtuu vastaanottajan vastuulla vv. Merikarvia, ellei muuta ole sovittu.
- Emme vastaa lähetysten mahdollisista purkukuluista.
- Pakkaus ei sisälly tavaran hintaan.
- Tilauksista, joiden arvo hinnastohinnoin laskettuna on pienempi kuin 50 euroa, emme myönnä alennusta.
- Mahdolliset huomautukset on tehtävä 8 päivän kuluessa tavaran vastaanottamisesta.
- Mikäli ostaja ei noudata edellä mainittua ilmoitus- ja reklamaatioaikaa, hän menettää oikeutensa vedota lähetysten virheisiin ja puutteisiin.
- Omistusoikeus tuotteeseen siirtyy ostajalle vasta, kun koko kauppahinta on maksettu.
- Kaikki mitat ja painot on ilmoitettu sitoumuksetta.

Takuuehdot

Takuaika toimitetuille tuotteille on 2 vuotta.

Takuu koskee Meriser Oy:n tuotteissa mahdollisesti ilmeneviä työ- ja ainevikoja.

Meriser Oy sitoutuu, oman valintansa mukaan, korjaamaan tai korvaamaan takuaikana vialliseksi todetun tuotteen. Myyjän vastuu muista kuin tuotteessa itsessään aiheutuvista vahingoista ja korvauksista määräytyy tuotevastuulain (694/1990) mukaisesti.

Mikäli tuotteen virheellinen käsittely, asennus tai muu sentapainen syy on todettavissa vian aiheuttajaksi, on toimittaja vapaa vastuusta.

Takuukorvaus suoritetaan vasta silloin, kun virheellinen tuote tai sen varioitunut osa on toimitettu Meriser Oy:n tehtaalte tarkastettavaksi ja vaurio on todettu takuukorvauksen piiriin kuuluvaksi.

Palautuksen liitteenä tulee olla kirjallinen selvitys vian laadusta ja synnystä sekä selvitys siitä, milloin tavara on toimitettu vastaanottajalle. Tilauksen tai laskun numero on ilmoitettava.

Reklamaatio-ohjeet

- Asiakkaalla on reklamaatiotapauksissa kahdeksan (8) päivän reklamaatioaika:
- Toimitusvirhe:
 1. Toimituksesta puuttuu tuote
 2. Toimituksessa väärä määrä
 3. Toimitettu väärää tuotetta
- Tilausvirhe
 1. Asiakas on tilannut väärää tuotteita ja haluaa palauttaa.
 2. Meriser Oy:n myyjän virhe tilauksella (asiakkaan tulee aina tarkistaa tilausvahvistus)
- Viallisesta tuotteesta on reklamoitava välittömästi kun tuotteen vika ilmenee, ei kuitenkaan myöhemmin kuin kolme (3) kuukautta toimituksesta. Poikkeuksena takuunalaiset tuotteet.
- Hinnoitteluvirheestä on reklamoitava välittömästi laskun saavuttua. Virhe ei oikeuta asiakasta siirtämään laskun maksua. Takuunalaisten tuotteiden viat on reklamoitava välittömästi vian ilmaannuttua.
- Asiakkaan tulee aina täyttää reklamaatiokaavake ja olla yhteydessä Meriser Oy:n myyjään. Yhteydenotto voi tapahtua lähettämällä täytetty reklamaatiolomake osoitteeseen merika@meriser.fi
- Meriser Oy ei käsittele reklamaatioita, joista ei ole täytetty yhtiön reklamaatiolomaketta. Lomake on saatavilla Meriser Oy:n nettisivuilla.

Vastuu ja muut ehdot

Meriser Oy:n vastuu tuotteiden virheistä sekä myös muu vastuu ja kaupan ehdot määräytyy muilta osin Teknisen Kaupan Liiton 2010 yleisten myyntiehtojen mukaan (TK Yleiset 2010).

Meriser Oy pidättää oikeuden hinta- ja alennusmuutoksiin.

Meriser Oy:llä on ISO 9001-sertifikaatti.

Meriser Oy:llä on tuotevastuu- ja takaisinvetovakuutus.

©2023 Meriser Oy

Sinua palvelevat

Quality for HVAC
Technology



Pasi Kuusinen

Toimitusjohtaja/
tekninen johtaja
pasi.kuusinen@meriser.fi

Kotimaan myynti

Reijo Aaka

Myyntipäällikkö
p. 045 138 1501
reijo.aaka@meriser.fi

Mikko Pajunen

LVI-myyjä
p. 040 450 1671
mikko.pajunen@meriser.fi

Mika Kuusinen

Tuote-edustaja
p. 040 511 6424
mika.kuusinen@meriser.fi

Vienti

Aila Hietikko

aila.hietikko@meriser.fi

Laskutus

Kirsi Arvola

merika@meriser.fi

Reskontra

Marjo Kuusinen

marjo.kuusinen@meriser.fi

Meriser Oy

tel.+358 (0)207 189 810
Kauppatie 2
29900 Merikarvia
Finland

Tilaukset 24/7

merika@meriser.fi
www.merika.fi
www.meriser.fi

**Tuotteisiin liittyviä mittakuvia,
asennusohjeita ja sertifikaatteja
löytyy kotisivuiltamme**

www.merika.fi
www.merika.fi/web/fi/documents

Sertifikaatti FI15/5016.01

SGS

Yrityksen

Meriser Oy

Kauppatie 2
29900 Merikarvia



johtamisjärjestelmä on arvioitu ja sertifioitu ja se täyttää seuraavat vaatimukset

ISO 9001:2015

Sertifioinnin laajuus

**LVIS -alan tarvikkeiden tuotekehitys,
valmistus, myynti ja markkinointi**

Tämä sertifikaatti on voimassa 25. maaliskuuta 2021 alkaen
24. maaliskuuta 2024 asti
Versio 4. Sertifioitu maaliskuusta 2015 lähtien

Valtuuttaa

Harri Kaartinen
Manager

FINAS
Finnish Accreditation Service
S009 (EN ISO/IEC 17021-1)

SGS Fimko Ltd
Takomotie 8, FI-00380 Helsinki, Finland
t +358 (0)9 6963 61 - f +358 (0)9 692 5474 www.sgs.fi

Sivu 1(1)



SGSSGS



Yritys on myöntänyt tämän asiakirjan Sertifiointipalvelujen yleisten ehtojensa mukaisesti, jotka ovat saatavilla osoitteessa http://www.sgs.com/terms_and_conditions.htm. Nämä ehdot sisältävät rajoituksia yrityksen vahingonkorvauksisuhteeseen, hyvityksiin ja lain valintaan. Tämän asiakirjan oikeellisuuden voi todeta osoitteesta <https://www.sgs.com/en/certified-clients-and-products/certified-client-directory>. Tämän asiakirjan sisältöön tai ulkoasuun luvuton muuttaminen, väärentäminen tai vääristely on lainvastainen ja tekijä voidaan asettaa syyteeseen lain ankarimmissa puoleissa.

1 Alipaineventtiilit

Quality for HVAC
Technology



MERIKA®

Alipaineventtiilit

- CE-merkitty
- Suomalainen tuote
- Saatavana myös lämpöeristettynä

Mitoitusohje Merika- alipaineventtiileille

kerrosten lukumäärä max.	tuuletus- viemärin koko mm	tuuletus- viemärin pituus max. m
3	75	3
2	50	3
8	75	5
8	110	20



1 Alipaineventtiilit

Quality for HVAC
Technology



Alipaineventtiili

Merika nro	LVI nro	koko	paino	kpl	EAN
100	4162744	32	0,040	10	6 4 1584 1 627448
107	4162754	70/75/100/110	0,335	10	6 4 1584 1 627547
107L*	4162756	70/75/100/110	0,362	10	6 4 1584 1 627561

* lämpöeristetty



Alipaineventtiilien varaosat

Merika nro	kuvaus	koko	paino	sopii Merika nro
100_03	APV-tiiviste	57 × 37 × 4	0,004	100
106_05	Styrox-hattu	147 × 168 × 75	0,013	107 ja 107L
106_03	APV-tiiviste	123 × 83 × 1,5	0,013	107 ja 107L

2 Ilmastuslaitteet

Quality for HVAC
Technology



MERIKA®



2 Ilmastuslaitteet

Quality for HVAC
Technology



Merika 120



Merika 120M



Merika 123



Merika 123M



Merika 124



Merika 125



Merika 125M



Merika 126



Merika 126M



Merika 127



Merika 129



Merika 135



Merika 135M



2 Ilmastuslaitteet

Quality for HVAC
Technology



● sopii putkeen ○ sopii putkeen ja muuviin ◆ kierresäätöinen

Ilmastusputken hattu					
Merika nro	LVI nro	koko	paino	kpl (ltk/lava)	EAN
● 120 harmaa	2378125	70	0,055	20	6 4 15823 781250
● 120M musta	2378948	70	0,055	20	6 4 38541 000335
○ 135 harmaa	2378121	70/75	0,084	100	6 4 15823 781212
○ 135M musta	2378947	70/75	0,084	100	6 4 38541 000328
● 125 harmaa	2378126	100	0,099	100	6 4 15823 781267
● 125M musta		100	0,099	100	
○ 123 harmaa	2378123	100/110	0,159	80	6 4 15823 781236
○ 123M musta		100/110	0,159	80	
● 126 harmaa	2378127	150	0,235	20	6 4 15823 781274
● 126M musta		150	0,235	20	
● 127 musta	2378128	200	2,169	10	6 4 15823 781281

Ilmastusputken hattu, kierresäätöinen					
○◆ 129 harmaa	2378321	70/75	0,116	50	6 4 15823 783216
○◆ 124 harmaa	2378323	100/110	0,212	50	6 4 15823 783230

Ilmastusputken säätöventtiili					
○ 131 harmaa	2378307	75	0,026	200	6 4 15823 783070
○ 131M musta	2378945	75	0,026	200	6 4 15823 789454
○ 132 harmaa	2378311	110	0,117	400	6 4 15823 783117
○ 132M musta	2378946	110	0,117	400	6 4 15823 789461



3 Lattiakaivot ja korotusrenkaat

Quality for HVAC
Technology



MERIKA®



3 Lattiakaivot ja korotusrenkaat

Quality for HVAC
Technology

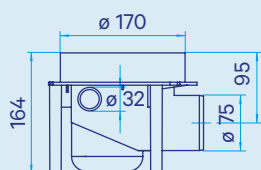

Merika 198

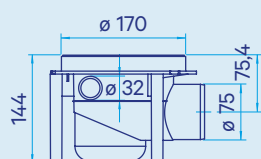

Merika 199

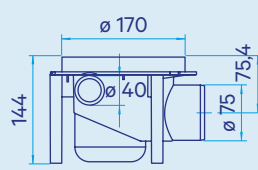

Merika 200

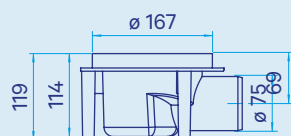

Merika 201

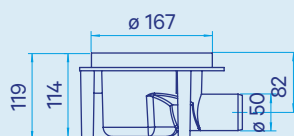

Merika 204

Vaakakaivot harmaa

Merika nro	LVI nro	kuvaus	paino	kpl	EAN
198	3311416	Merika lattiakaivo vaaka, korkea malli 75 mm • 32 mm sivul. • sis. 2 kpl korokeyiiloja • virtaama 1,5 l/s	0,700	12/240	6 4 15833 114 161
199	3311443	Merika lattiakaivo vaaka 75 mm • 32 mm sivul. • virtaama 1,44 l/s	0,628	15/300	6 4 15833 114 437
200	3311426	Merika lattiakaivo vaaka 75 mm • 40 mm sivul. • virtaama 1,44 l/s	0,655	13/260	6 4 15833 114 260
201	3311428	Merika lattiakaivo vaaka, matala malli 75 mm • korkeus 119 mm • virtaama 0,99 l/s	0,5218	16/320	6 4 15833 114 284
204	3311429	Merika lattiakaivo vaaka, matala malli 50 mm • korkeus 119 mm • virtaama 0,82 l/s	0,5134	16/320	6 4 15833 114 291

Hyväksytyt vedeneristysaineet:

katso ajantasaiset tiedot verkkosivuiltamme www.merika.fi

3 Lattiakaivot ja korotusrenkaat



Quality for HVAC
Technology



Merika 211



Merika 212



Merika 221



Merika 222



Merika 2212



Merika 1991

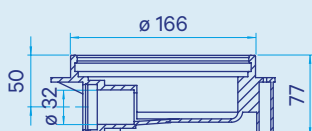
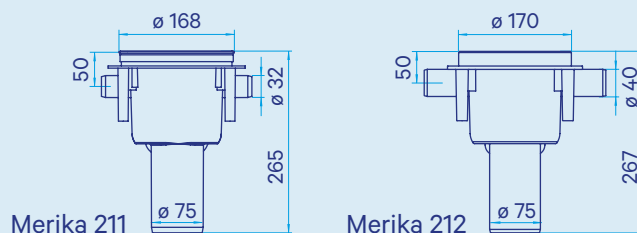

Merika 221

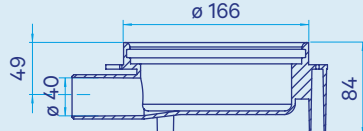

Merika 222

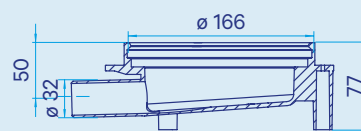

Merika 2212

Pystykaivot harmaa

Merika nro	LVI nro	kuvaus	paino	kpl (ltk/lava)	EAN
211	3312413	Merika pystykaivo 75 mm • 32 mm sivuliitännällä • virtaama 1,8 l/s	0,620	10/200	6 4 15833 124139
212	3311427	Merika pystykaivo 75 mm • 40 mm sivuliitännällä • virtaama 2,0 l/s	0,647	10/200	6 4 15833 114277

Kuivakaivot harmaa

221	3310431	Merika kuivakaivo 32 mm muhvilla • virtaama 0,4 l/s	0,260	15/450	6 4 15833 104315
222	3311418	Merika kuivakaivo 40 mm poistolla • virtaama 0,8 l/s	0,329	15/450	6 4 15833 114185
2212	3311433	Merika kuivakaivo 32 mm poistolla • virtaama 0,51 l/s • matala reuna-korkeus	0,355	15/450	6 4 15833 114338

Lattiakaivon sivuliitännän avaustyökalu

1991	3311417	Merika lattiakaivon sivuliitännän avaustyökalu 32 mm	0,024	10	6 4 15833 114178
1992	3311425	Merika lattiakaivon sivuliitännän avaustyökalu 40 mm	0,034	1	6 4 15833 114253
1993		Merika lattiakaivon sivuliitännän avaustyökalu 50 mm	0,082	1	

Hyväksytyt vedeneristysaineet:

katso ajantasaiset tiedot verkkosivuiltamme www.merika.fi

3 Lattiakaivot ja korotusrenkaat



Quality for HVAC
Technology



Lattiakaivot säätöjaloin Sisältää kaivon ja säätöjalkasarjan

Merika nro	LVI nro	kuvaus	paino	kpl (ltk/lava)	EAN
198194	3311452	Merika lattiakaivo vaaka, korkea malli 75 mm säätöjaloin 32 mm sivuliitântä	1,121	10	6 43854 1000601
199194	3311455	Merika 75 lattiakaivo vaaka säätöjaloin STF 32 mm sivuliitântä	1,011	12	6 43854 1000632
211194	3311454	Merika pystykaivo 75 mm säätöjaloin STF 32 mm sivuliitântä	1,06	10	6 43854 1000625
221194	3311453	Merika kuivakaivo 32 mm muhvilla säätöjaloin	0,697	10	6 43854 1000618

Lattiakaivon jalat

Merika nro	LVI nro	kuvaus	paino	kpl	EAN
194	3311450	Merika lattiakaivon säätöjalkasarja • 3 jalkaa/pss	0,336		6 43854 1000595
19411		Merika 194 säätöjalkasarjan 100 mm jatkosarja • 3 jatkoa/pussi			
195	3311414	Merika lattiakaivon jalka • sis. ruuvit ja kärjen	0,273	40/240	6 415833 114147

3 Lattiakaivot ja korotusrenkaat

Quality for HVAC
Technology



Kuivakaivot					
Merika nro	LVI nro	kuvaus	paino	kpl (ltk/lava)	EAN
225	3310452	Merika kuivakaivo 50 mm	0,232	15	6 4 15833 104520
226	3310453	Merika kuivakaivo 75 mm	0,594	15	6 4 15833 104537
227	3310454	Merika kuivakaivo 110 mm	0,626	15	6 4 15833 104544

Kuivakaivot alumiinivalukannella					
Merika nro	LVI nro	kuvaus	paino	kpl	EAN
375	3638081	Merika kuivakaivo 75 mm	2,370	1	6 4 15836 380815
376	3638083	Merika kuivakaivo 110 mm	2,410	1	6 4 15836 380839

3 Lattiakaivot ja korotusrenkaat



Quality for HVAC
Technology



Merika 400



Merika 401



Merika 4011



Merika 412



Merika 413



Merika 414

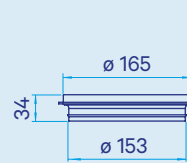

Merika 400

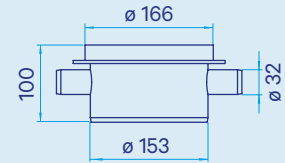

Merika 401

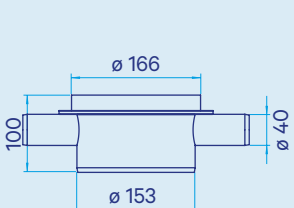

Merika 4011

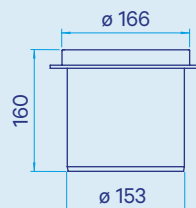

Merika 412

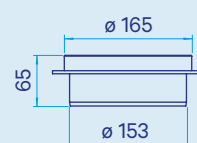

Merika 413

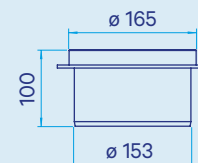

Merika 414

Korotusrenkaat

Merika nro	LVI nro	kuvaus	paino	kpl (ltk/lava)	EAN
400	3318112	Merika korotusrenkas erikoismatala 150 × 34 • korotus 12 mm	0,070	15	6 415833 181125
401	3318110	Merika korotusrenkas UMK-K 32 mm	0,296	20/400	6 415833 181101
4011	3311431	Merika korotusrenkas UMK-K 40 mm	0,296	20/400	6 415833 114314
412*	3318117	Merika korotusrenkas 150 × 160	0,402	10/200	6 415833 181170
413*	3318111	Merika korotusrenkas 150 × 65	0,175	15	6 415833 181118
414*	3318155	Merika korotusrenkas 150 × 100	0,272	20/400	6 415833 181552

*) minimikorotus 25 mm

Hyväksytyt vedeneristysaineet:

katso ajantasaiset tiedot verkkosivuiltamme www.merika.fi

3 Lattiakaivot ja korotusrenkaat

Quality for HVAC
Technology



Korotusrenkaat saneeraukseen						
Merika nro	LVI nro	kuvaus	paino	kpl (ltk/lava)	EAN	
411	3318115	Merika korotusrenkas 150 × 100 saneerausmalli tiivistein ja tukiritaliön • matto- ja vesieristysasennukseen	0,133	20/480	6 4 15833 181156	
415	3318175	Merika valukorotusrenkas 148 × 48, valkoinen VESIERISTYKSEN YLÄPUOLELLE	0,080	20	6 4 15833 181750	
421	3318165	Merika korotusrenkas 150x100 saneerausmalli tiivistein ja tukiritaliön • laatta-asennukseen, EI VESIERISTEASENNUKSEEN	0,132	20/480	6 4 15833 181651	

Vesieristyslaipat						
Merika nro	LVI nro	kuvaus	paino	kpl (ltk/lava)	EAN	
457	3319671	Merika vesieristyslaippa säädettävin kiillarenkain ø 150	0,122	30/750	6 4 15833 196716	
458	3319673	Merika vesieristyslaippa lattiakaivoille ø 150 • asennetaan kaivoon omalla kiillarenkaalla	0,086	10	6 4 15833 196730	
4581	3319674	Merika vesieristyslaippa korotusrenkaalle M-400	0,086	10	6 4 15833 196747	

Hyväksytyt vedeneristysaineet:

katso ajantasaiset tiedot verkkosivuiltamme www.merika.fi

3 Lattiakaivot ja korotusrenkaat

Quality for HVAC
Technology



Lattiakaivojen varaosat					
Merika nro	LVI nro	kuvaus	paino	kpl (ltk/lava)	EAN
196	3311422	Merika vesilukon takaisku • jälkiasennettavissa tyyppihyväksytyihin Merika lattiakaivoihin, joissa on kahvallinen vesilukko	0,007		6 415833 114222
197	3311438	Merika vaakakaivon vesilukko (alkaen 3.2.2017) • sopii kaivoihin 198, 199 ja 200	0,1094		6 438541 000427
1971	3311424	Merika vaakakaivon takaiskullinen vesilukko (3.2.2017 alkaen) • ehkäisee vesilukon kuivumista ja hajuhaittoja • sopii kaivoihin 198, 199 ja 200	0,1186	10 kpl/ ltk	6 415833 114246
205	3311439	Merika matalan vaakakaivon vesilukko • sopii kaivoihin 201 ja 204	0,0735		6 438541 000434
2051	3311430	Merika matalan vaakakaivon takaiskullinen vesilukko • sopii kaivoihin 201 ja 204	0,0833		6 415833 114307
211_02		Merika pystykaivon vesilukko, vanha malli tulpall. • sis. ruuvit	0,101		
213	3311440	Merika pystykaivon vesilukko (3.2.2017 alkaen) • sopii kaivoihin 211 ja 212	0,1031		6 438541 000441
21311	3312414	Merika pystykaivon takaiskullinen vesilukko (3.2.2017 alkaen) • ehkäisee vesilukon kuivumista ja hajuhaittoja • sopii kaivoihin 211 ja 212	0,1122	10 kpl/ ltk	6 415833 124146

Jatkuu seuraavalla sivulla

3 Lattiakaivot ja korotusrenkaat

Quality for HVAC
Technology



Lattiakaivojen varaosat						
Merika nro	LVI nro	kuvaus	paino	kpl (ltk/lava)	EAN	
199_05	3311444	Lattiakaivon vesilukon tiiviste • sopii kaivoihin 198, 199, 200	0,005		6 438541 000526	
OR1171X353	3311448	Pystykaivon vesilukon tiiviste • sopii kaivoihin 211, 212	0,005		6 438541 000564	
202_03	3311447	Lattiakaivon huulitiiviste • sopii Merika-korotusrenkasiin 400, 401, 4011, 412, 413 ja 414 • sopii Merika-kaivoihin 198, 199, 200, 201, 204, 211, 221, 222, 212, 2212	0,018		6 438541 000557	
OR125X25	3311449	Matalan vaakakaivon vesilukon tiiviste • sopii kaivoihin 201, 204	0,101		6 438541 000571	
431	3315711	Merika kansi 150, valkoinen	0,060	50	6 415833 157113	
432	3315710	Merika kansi 150, kromattu	0,060	20	6 415833 157106	
432M		Merika kansi 150 mm, musta	0,060			
435	3315721	Merika kansi 152, paksu valkoinen	0,065	20	6 415833 157212	
4371	3311419	Merika kansi RST 150, 9 mm korkea	0,136		6 415833 114192	
43711	3311437	Merika kansi RST 150, 9 mm korkea/32 reiällä	0,132		6 415833 114376	

Jatkuu seuraavalla sivulla

3 Lattiakaivot ja korotusrenkaat

Quality for HVAC
Technology



Lattiakaivojen varaosat						
Merika nro	LVI nro	kuvaus	paino	kpl (ltk/lava)	EAN	
440		Merika korokeyiila, sopii kaivoon 198	0,026			
441	3319215	Merika kiilarengas 150 mm	0,035		6 4 15833 192152	
445	3315781	Merika umpikansi 150 mm	0,123	30	6 4 15833 157816	
446	3319285	Merika sääd. kiilarengas 148-157 mm	0,046	100/4500	6 4 15833 192855	
448	3319280	Merika kiilarengas 148 mm	0,030	10	6 4 15833 192800	
455	3318192	Merika saneerauskorotusrenkaan tiiviste	0,021	10	6 4 15833 181927	
200_01	3319721	Merika puhdistustulppa, halk. 25 mm	0,004	20/500	6 4 15833 197218	
200_03	3319722	Merika puhdistustulppa, halk. 31 mm	0,006	10/500	6 4 15833 197225	

4 Hiekkanerotuskaivot ja korotusrenkaat

Quality for HVAC
Technology



MERIKA®



4 Hiekanerotuskaivot ja korotusrenkaat

Quality for HVAC Technology

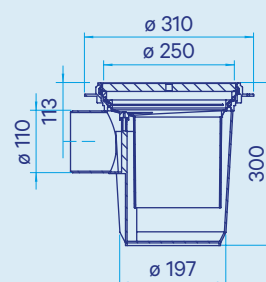
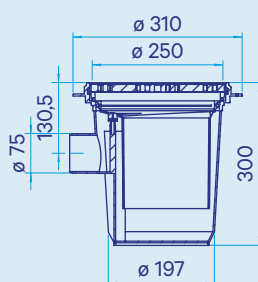
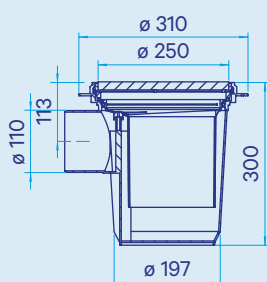
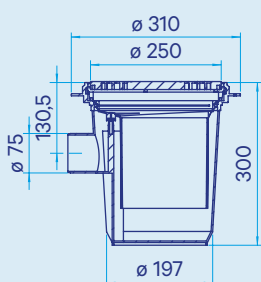

Merika 331

Merika 332

Merika 341

Merika 351

PH-kaivot

Merika nro	LVI nro	koko	paino	kpl (ltk/lava)	EAN
PH 7/75 331	3638001	75	1,950	4/72	6 4 15836 380013
PH 7/110 332	3638006	110	1,970	4/72	6 4 15836 380068

• muovia • muovikannella • tilavuus 7,7 litraa • helppo puhdistaa • esim. tallit, pannuhuoneet, varastot, kuraeteiset ym. • väri harmaa

PHV-kaivot

PHV 7/75 341	3638002	75	2,700	4/72	6 4 15836 380020
PHV 7/110 351	3638007	110	2,720	4/72	6 4 15836 380075

• muovia • 25 cm alumiinikannella • tilavuus 7,7 litraa • helppo puhdistaa • esim. tallit, pannuhuoneet, varastot, kuraeteiset ym. • väri harmaa • alumiinikannen kantavuus 1,5 tn

Hyväksytyt vedeneristysaineet:

katso ajantasaiset tiedot verkkosivuiltamme www.merika.fi

Virtaamat: 75 mm 1,6 l/s • 110 mm 1,9 l/s

Saatavana hiekanerotuskaivoihin sopivia RST-neliökansia (sivu 50).

4 Hiekanerotuskaivot ja korotusrenkaat

Quality for HVAC Technology

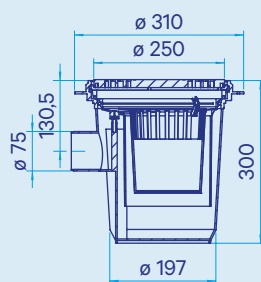

Merika 359

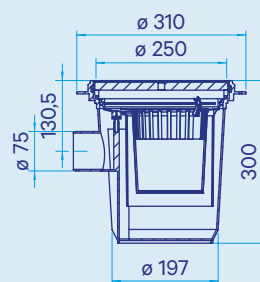

Merika 361

PHS- ja PHVS-kaivot irtosangolla

Merika nro	LVI nro	koko	paino	kpl (ltk/lava)	EAN
PHS 7/75 359	3638012	75	2,110	4/72	6 4 15836 380129
PHS 7/110 360	3638013	110	2,120	4/72	6 4 15836 380136
PHVS 7/75 361	3638003	75	2,850	4/72	6 4 15836 380037
PHVS 7/110 362	3638008	110	2,860	4/72	6 4 15836 380082

- muovia • tilavuus 7,7 litraa • helppo puhdistaa • esim. tallit, pannuhuoneet, varastot, kuraeteiset ym.
- väri harmaa

PHS = muovikannella ja irtosangolla **PHVS** = alumiinikannella ja irtosangolla

Sanko PH- ja PHV-kaivoille

329	3638698		0,154	4	6 4 15836 386985
------------	---------	--	-------	---	------------------

Hyväksytyt vedeneristysaineet:

katso ajantasaiset tiedot verkkosivuiltamme www.merika.fi

**Saatavana hiekanerotuskaivoihin
sopivia RST-neliökansia (sivu 50).**

4 Hiekanerotuskaivot ja korotusrenkaat

Quality for HVAC Technology

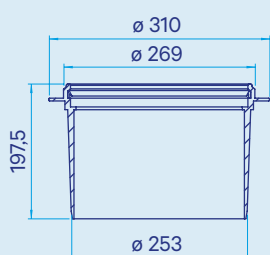

Merika 337

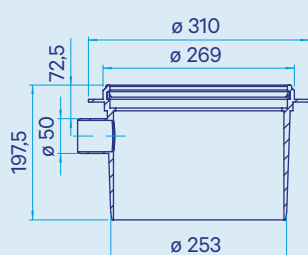

Merika 336

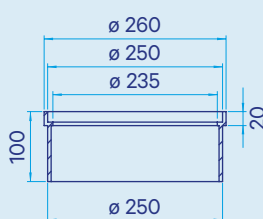

Merika 335

PH-korotusrenkas kätevä, patentoitu ruuviinnitys lattiakaivoon

Merika nro	LVI nro	koko	paino	kpl	EAN
337	3638095	Ø 250 × 197	0,852	6	6 4 15836 380952

- matto- ja laatta-asennukseen • puu- ja betonilattioille • väri harmaa • kumitiivisteellä • 4 kpl ruuveja
- minimikorotus 37 mm

PH-korotusrenkas kätevä, patentoitu ruuviinnitys lattiakaivoon

336	3638096	Ø 250 × 197	0,858	6	6 4 15836 380969
-----	---------	-------------	-------	---	------------------

- matto- ja laatta-asennukseen • puu- ja betonilattioille • väri harmaa • kumitiivisteellä • 4 kpl ruuveja
- sivuliitäntä 50, avattava

PH-valukorotusrenkas

335	3638092	kork. 100/Ø 250	0,316	1	6 4 15836 380921
-----	---------	-----------------	-------	---	------------------

- valkoinen • vain vesieristyksen yläpuoliseen asennukseen

Vesieristyslaippa PH-kaivolle Ø 250

327	3319672	Ø 250	0,141		6 4 15833 196723
-----	---------	-------	-------	--	------------------

Hyväksytyt vedeneristysaineet:

katso ajantasaiset tiedot verkkosivuiltamme www.merika.fi

4 Hiekanerotuskaivot ja korotusrenkaat

Quality for HVAC
Technology



Merika 315

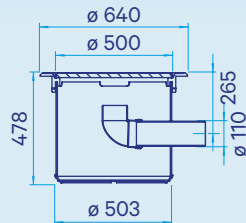

Merika
98981



Merika
98982

LKV 110/500

Merika nro	LVI nro	koko	korkeus	paino	kpl	EAN
315	3638063	LKV 110/500	465	65,8	1	6 4 15836 38063 1

- 5 tn kansi ja kehys valurautaa

Hiekankerääjä pesuaitalle korkeus 300 mm, ø 160 mm

98981	3638071	1 1/2 × 32	300	1,7	1	6 4 15836 38071 6
98982	3638072	1 1/2 × 50	300	1,7	1	6 4 15836 38072 3

4 Hiekanerotuskaivot ja korotusrenkaat

Quality for HVAC
Technology



Hiekanerotuskaivojen varaosat						
Merika nro	LVI nro	kuvaus	paino	kpl	EAN	
328	3319295	Merika PH-kaivon kiilarengas ø 250	0,063		6 415833 192954	
442	3315751	Merika kansi 250 mm valkoinen	0,318	5	6 415833 157519	
442_01		Merika kansi 250 mm, musta	0,318	1		
443	3315765	Merika kansi 250 mm alumiini, kantavuus 1,5 tn	1,077	1	6 415833 157656	
331_03		PH-kaivon sisäosa	0,263			
332_02		PH-kaivon yläpään tiiviste	0,035			

5 Öljynerotuskaivot

Quality for HVAC
Technology



MERIKA®



5 Öljynerotuskaivot

Quality for HVAC
Technology

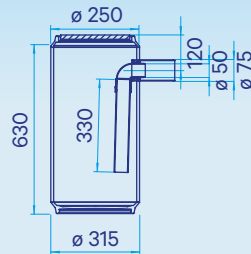

Merika 333

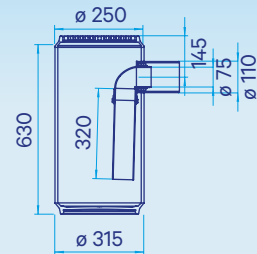

Merika 352

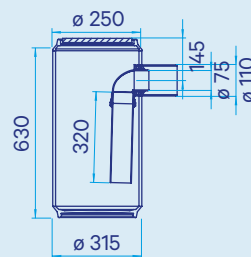

Merika 334

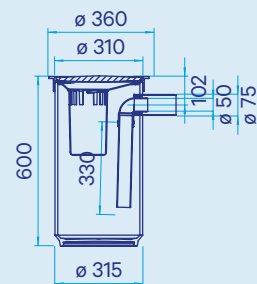

Merika 343

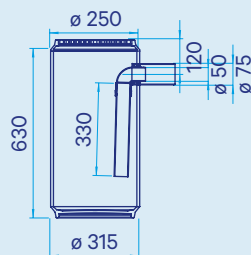

Merika 342

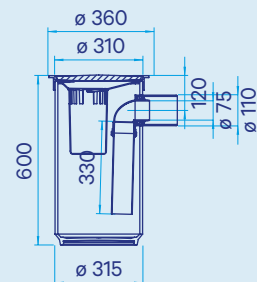

Merika 353

PH 30/75, PH 30/110, PHV 30/75, PHV 30/110

Merika nro	LVI nro	koko	paino	kpl	EAN
333 muovikannella	3638022	PH 30/75	6,0	1	6 4 15836 380228
334 muovikannella	3638032	PH 30/110	6,1	1	6 4 15836 380327
342 alumiinikannella	3638020	PHV 30/75	6,8	1	6 4 15836 380204
352 alumiinikannella	3638030	PHV 30/110	6,9	1	6 4 15836 380303

• helppo puhdistaa • käyttökohteita autotallit, pannuhuoneet yms. • irrotettava vesilukko

PHVS 30/75 JA 30/110 irtosangolla kansi alumiinia

343	3638024	PHVS 30/75	8,7	1	6 4 15836 380242
353	3638034	PHVS 30/110	8,8	1	6 4 15836 380341

• käyttökohteita autotallit, pannuhuoneet, varastot yms. • irrotettava vesilukko

5 Öljynerotuskaivot

Quality for HVAC
Technology



Merika 310

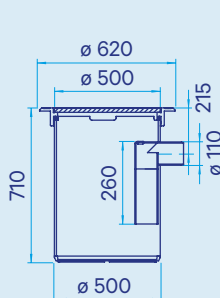

Merika 310



Merika 312

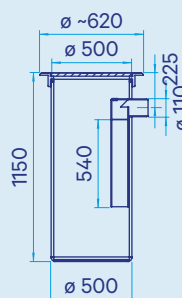

Merika 312



Merika
321

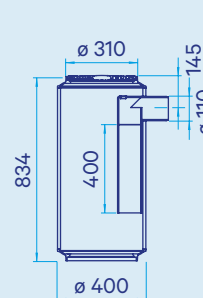

Merika 321



Merika
322

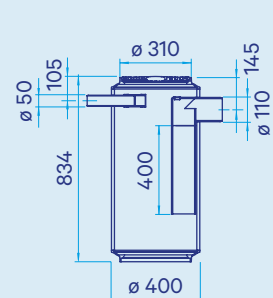

Merika 322

PHV 110 40/500

Merika nro	LVI nro	koko	kork.	paino	kpl	EAN
310	3638045	PHV 110 40/500	710	69,1	1	6 4 15836 380457

- hiekanerotustila 40 litraa • 5 tn ritiläkansi ja kehys valurautaa

PVMH 110 40/500 täyttää YM:n asetuksen 63/2023 vaatimukset

312	3638040	PVMH 110 40/500	1150	76,2	1	6 4 15836 380402
-----	---------	-----------------	------	------	---	------------------

- hiekanerotustila 40 litraa • 5 tn ritiläkansi ja kehys valurautaa

PHV 110 40/400

321	3638050	PHV 110 40/400	834	13,4	1/18 ltk/lava	6 4 15836 380501
322	3638004	PHV 110 40/400 • 50 mm tuloyhteellä	834	13,6	1/18 ltk/lava	6 4 15836 380044

- hiekanerotustila 40 litraa • alumiinivalukansi

5 Öljynerotuskaivot

Quality for HVAC
Technology



Öljynerotuskaivojen varaosat					
Merika nro	LVI nro	kuvaus	paino	kpl	EAN
343_01		Merika irtosanko, musta	0,335	1	
442_01		Merika kansi 250 mm, musta	0,318	1	
443	3315765	Merika kansi 250 mm, alumiini, kantavuus 1,5 tn	1,077	1	6 4 15833 157656
1748	3638094	Merika korotusrenkas ø 310 kork. 200	1,700	1	6 4 15836 380945
1749	3315775	Merika kansi 310 alumiini, kantavuus 2 tn	1,619	1	6 4 15833 157755

6 Peitelaatat

Quality for HVAC
Technology



MERIKA®



6 Peitelaatat

Quality for HVAC
Technology



○ valkoinen ○ kromattu ◆ beige

Lukittava peitelaatta, muovia						
Merika nro	LVI nro	väri/koko	paino	kpl	ø	EAN
○ 541	6501802	valkoinen/10 mm	0,001	24	40	6 415865 018024
○ 542	6501803	valkoinen/12 mm	0,002	24	40	6 415865 018031
○ 543	6501804	valkoinen/15 mm	0,003	24	48	6 415865 018048
○ 544	6501805	valkoinen/18 mm	0,003	24	50	6 415865 018055
○ 545	6501806	valkoinen/22 mm	0,004	24	61	6 415865 018062
○ 546	6501807	valkoinen/28 mm	0,004	24	70	6 415865 018079
○ 547	6501808	valkoinen/35 mm	0,005	24	75	6 415865 018086
○ 548	6501809	valkoinen/42 mm	0,006	24	89	6 415865 018093
○ 560	6501822	kromattu/10 mm	0,001	25	40	6 415865 018222
○ 561	6501823	kromattu/12 mm	0,002	25	40	6 415865 018239
○ 562	6501824	kromattu/15 mm	0,003	25	48	6 415865 018246
○ 563	6501825	kromattu/18 mm	0,003	25	50	6 415865 018253
○ 564	6501826	kromattu/22 mm	0,004	25	61	6 415865 018260
○ 565	6501827	kromattu/28 mm	0,004	25	70	6 415865 018277
◆ 570	6501832	beige/10 mm	0,001	25	40	6 415865 018321
◆ 571	6501833	beige/12 mm	0,002	25	40	6 415865 018338
◆ 572	6501834	beige/15 mm	0,003	25	48	6 415865 018345
◆ 573	6501835	beige/18 mm	0,003	25	50	6 415865 018352
◆ 574	6501836	beige/22 mm	0,004	25	61	6 415865 018369
◆ 575		beige/28 mm		25		



6 Peitelaatat

Quality for HVAC
Technology



Kolmen koon peitelaatta, muovia

Merika nro	LVI nro	koko	paino	kpl	EAN
510	5688050	50 – 75 – 110	0,037	5/100	6 4 15856 880500

• leikattava • asennus mm. tiskipöytäkaappiin • ø 173 mm valkoinen

Armi-saneeraustulppa

590	6501873	vaal.harmaa	0,003	20	6 4 15865 018734
591	6501874	t.harmaa	0,003	20	6 4 15865 018741
592	6501875	beige	0,003	20	6 4 15865 018758

• sopii 3/8”–1/2” käytöstä poistettujen armiputkien siistiin tulppaukseen

Peitelaatat komposiittiputkille

525	6501810	ø 16, valk.	0,003	25	6 4 15865 018109
527	6501811	ø 20, valk.	0,003	25	6 4 15865 018116

7 Hanakulmat ja viemäröntiosat

Quality for HVAC Technology



MERIKA®



7 Hanakulmat ja viemäröntiosat

Quality for HVAC
Technology



Aimo-hanakulma					
Merika nro	LVI nro	koko	paino	kpl	EAN
601 kromattu	2372334	¾ × 32	0,080	20	6 4 15823 723342
602 valkoinen	2372434	¾ × 32	0,079	20	6 4 15823 724349

• kromatulla tai valkoisella peitelaijalla • pinta-asennukseen • pesukoneen poistoputkelle

Aimo-pinta-asennuskulma ja viemäröntikappale					
Merika nro	LVI nro	koko	paino	kpl	EAN
681 kromattu	2372530	¾ × 32	0,108	10	6 4 15823 725308
682 valkoinen	2372531	¾ × 32	0,108	10	6 4 15823 725315

Asennussarja, Aimo-pinta-asennuskulma, viemäröntikappale ja -putki 32 × 1000 mm					
Merika nro	LVI nro	koko	paino	kpl	EAN
695 kromattu	2372540		0,328	1	6 4 15823 725407
696 valkoinen	2372541		0,328	1	6 4 15823 725414

7 Hanakulmat ja viemäröntiosat

Quality for HVAC
Technology



Vellu-hanakulma pesukoneen poistolle

Merika nro	LVI nro	koko	paino	kpl (ltk/lava)	EAN
611 messinki	2372444	¾ × 32	0,260	50	6 4 15823 724448
6112* messinki, pitkä	2372337	¾ × 32	0,302	50	6 4 15823 723373
612 lasikuituvahv. nylon	2372454	¾ × 32	0,048	50	6 4 15823 724547

Maija-hanakulma pesukoneen poistolle

632 messinki	2372234	¾ × 28	0,282	50	6 4 15823 722345
6323* messinki, pitkä	2372339	¾ × 28	0,289	50	6 4 15823 723397

- sopii 32 PP-putken sisään

Vellu- ja Maija-hanakulmat IV-koneen poistolle

6111 messinki	2372335	½ × 32	0,245	50	6 4 15823 723359
6321 messinki	2372336	½ × 28	0,289	50	6 4 15823 723366
6322** messinki, pitkä	2372338	½ × 28	0,289	50	6 4 15823 723380

*) 3/4" kierre on 15 mm pidempi kuin perusmallissa.

***) 1/2" kierre on 15 mm pidempi kuin perusmallissa.

7 Hanakulmat ja viemäröntiosat

Quality for HVAC
Technology



Viemäröntikappale

Merika nro	LVI nro	koko	paino	kpl	EAN
1500 valkoinen	6209581	¾ × 19	0,042	20	6 4 15862 095813
1501 kromattu	6209580	¾ × 19	0,044	20	6 4 15862 095806

Viemäröntirengas, pesualtaalle ja -pöydälle

1509 valkoinen	6209481		0,070	50	6 4 15862 094816
1509M musta			0,070	50	
1511 valkoinen	6209483		0,075	50	6 4 15862 094830
1511M musta			0,075	50	

PP-poistoputki

Merika nro	LVI nro	koko	paino	kpl pss/kehikko	EAN
604 kromattu	2372580	32 × 1000	0,175	10	6 4 15823 725803
605 valkoinen	2372581	32 × 1000	0,170	10	6 4 15823 725810
606 musta	2449429	32 × 1000	0,170	10	6 4 15824 494296
2114 valkoinen	2372591	32 × 3000	0,520	10/120/240	6 4 15823 725919

7 Hanakulmat ja viemäröntiosat

Quality for HVAC
Technology



PP-poistoputki muhvilla					
M6051 valkoinen	2449427	32 × 1000	0,185	10	6 4 15824 494272
M6051M musta		32 × 1000	0,185	10	
M6052 valkoinen	2449428	32 × 1500	0,272	10	6 4 15824 494289

Pesukoneen liitosyhde muhvilla					
Merika nro	LVI nro	koko	paino	kpl (ltk/lava)	EAN
1516 valkoinen	2371164	32 × 21	0,036	50	6 4 15823 711646
1517 kromattu	2371162	32 × 21	0,036	50	6 4 15823 711622
1516M musta	2362134	32 × 21	0,036	50	6 4 38541 000670

Pesukonesuppilo muhvilla					
1515 valkoinen	2371159	32	0,053	10	6 4 15823 711592

7 Hanakulmat ja viemäröntiosat

Quality for HVAC
Technology



Viemäröntiosien varaosat					
Merika nro	LVI nro	kuvaus	paino	kpl	EAN
1509_03	6209488	Viemäröntirenkaan muototiiviste ø 68 × 48 × 5,6	0,008	10 /pss	6 415862 094885
1509_04		Viemäröntirenkaan korokepala	0,018		
15091	6502836	Viemäröntirenkaan tulppa 1509_02, LVI-nro 6209489	0,100	100 /pss	6 438541 000274
15092	6502835	Viemäröntirenkaan tulppa 1509_02, LVI-nro 6209489	0,010	10 /pss	6 438541 000281
1513	6209486	Viem.renkaan kiinnitysruuvi, 6 × 90	0,018	10 /pss	6 415862 094861
1514	6209487	Viem.renkaan solumuovitiiv. 60/43 × 8	0,001	10 /pss	6 415862 094878

8 Suihkuletkut, poisto- ja tuloletkut

Quality for HVAC
Technology



MERIKA®



8 Suihkuletkut, poisto- ja tuloletkut

Quality for HVAC
Technology



Suihkuletkut					
Merika nro	LVI nro	koko	paino	kpl	EAN
853 kr./muovi	6585810	1,5 m	0,217	1	6 4 15865 858101
854 kr./muovi	6585820	2,0 m	0,266	1	6 4 15865 858200
857 kr./muovi	6585811	2,5 m	0,320	1	6 4 15865 858118
858 kr./muovi	6585812	3,0 m	0,402	1	6 4 15865 858125
859 kr./muovi	6585813	4,0 m	0,469	1	6 4 15865 858132
855 valk./muovi	6585851	1,5 m	0,235	1	6 4 15865 858514
856 valk./muovi	6585861	2,0 m	0,295	1	6 4 15865 858613

RST/PEX-asennusletku STF					
Merika nro	LVI nro	koko	Paino	kpl	EAN
9311	6584296	½ × ½ × 300	0,107	1	6 4 15865 842964
9312	6584297	½ × ½ × 400	0,117	1	6 4 15865 842971
9313	6584298	½ × ½ × 500	0,126	1	6 4 15865 842988
9314		½ × 10 suora × 300	0,085	1	
9315	6584299	½ × 10 suora × 400	0,094	1	6 4 15865 842995
9316		½ × 10 pus. × 400	0,115	1	

8 Suihkuletkut, poisto- ja tuloletkut

Quality for HVAC
Technology



RST-tulovesiletku pesukoneelle R ½ suora × ¾ kulma

Merika nro	LVI nro	koko	paino	kpl	EAN
840	6584051	1,5 m	0,315	1	6 4 15865 840519
841	6584052	2,0 m	0,394	1	6 4 15865 840526
842	6584053	2,5 m	0,488	1	6 4 15865 840533
843	6584054	3,0 m	0,565	1	6 4 15865 840540
844	6584056	4,0 m	0,706	1	6 4 15865 840564
845	6584058	5,0 m	0,875	1	6 4 15865 840588
840V valkoinen	6584059	1,5 m	0,253	1	6 4 15865 840595
841V valkoinen	6584060	2,0 m	0,311	1	6 4 15865 840601
842V valkoinen	6584061	2,5 m	0,302	1	6 4 15865 840618
843V valkoinen	6584062	3,0 m	0,370	1	6 4 15865 840625

Pesukoneen poistoletku

849	6584290	1,0 m	0,083	1	6 4 15865 842902
850	6584291	1,5 m	0,127	1	6 4 15865 842919
851	6584292	2,0 m	0,161	1	6 4 15865 842926
852	6584293	3,0 m	0,219	1	6 4 15865 842933

Pesukoneletkun jatko

91248		20-20	0,010	10	
91249		24-20	0,011	10	

9 Neliökannet

Quality for HVAC
Technology



MERIKA®

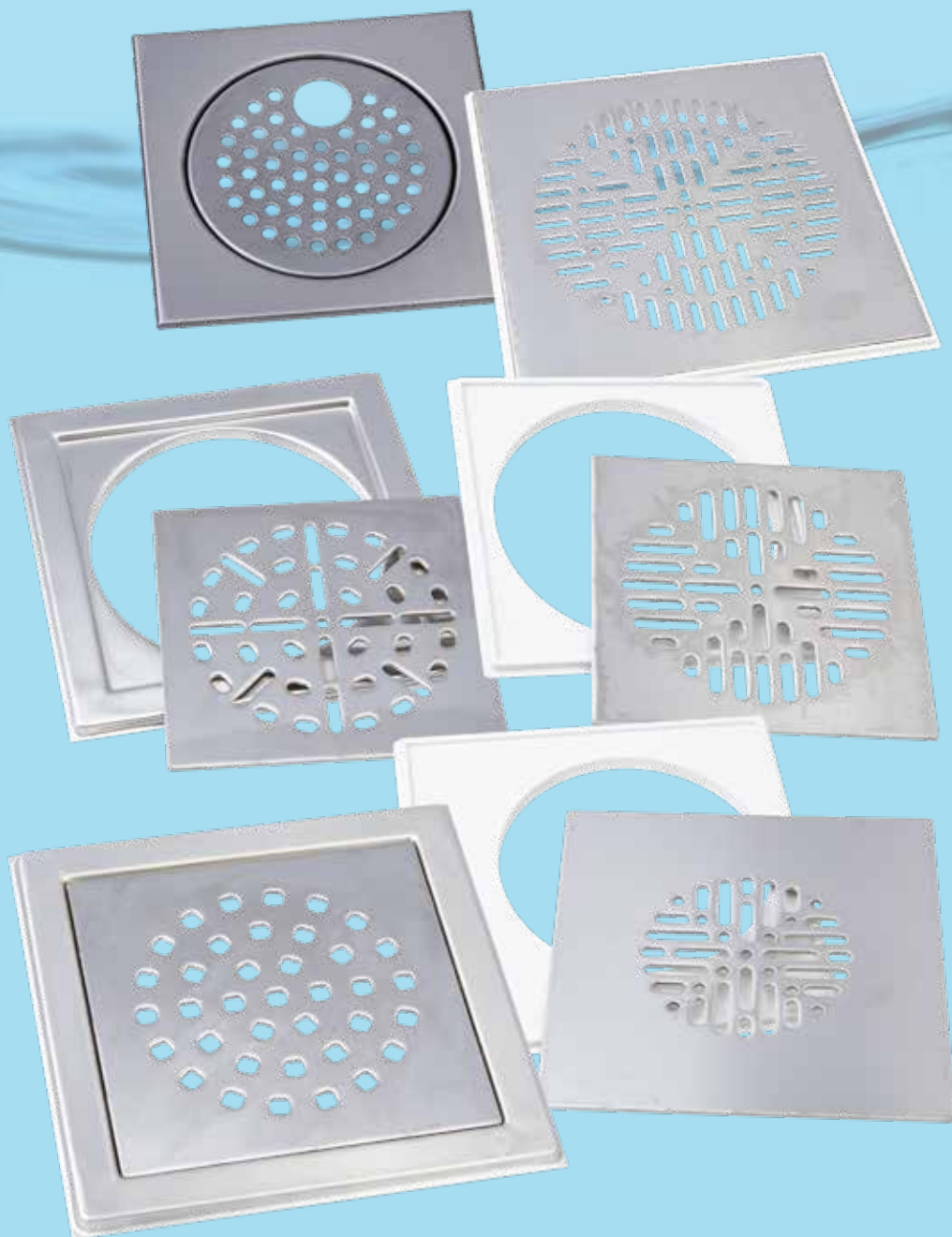

9 Neliökannet

Quality for HVAC
Technology



Merika 901



Merika 962



Muovinelökansi, epäkeskeinen

Merika nro	LVI nro	EAN
901 valkoinen	3316801	6 4 15833 168010
902 ruskea	3316802	6 4 15833 168027
903 harmaa	3316803	6 4 15833 168034
904 beige	3316804	6 4 15833 168041
905 taivaansininen	3316805	6 4 15833 168058
906 rosa	3316806	6 4 15833 168065
907 vaaleanvihreä	3316807	6 4 15833 168072
908 tummanvihreä	3316808	6 4 15833 168089

• Koko: 204 × 204 mm • Paino 0,247 • Kpl/ltk: 20

Muovinelökansi

Merika nro	LVI nro	EAN
961 valkoinen	3316821	6 4 15833 168218
962 ruskea	3316822	6 4 15833 168225
963 harmaa	3316823	6 4 15833 168232
964 beige	3316824	6 4 15833 168249
965 taivaansininen	3316825	6 4 15833 168256
966 rosa	3316826	6 4 15833 168263
967 vaaleanvihreä	3316827	6 4 15833 168270
968 tummanvihreä	3316828	6 4 15833 168287

• Koko: 204 × 204 mm • Paino 0,204 • Kpl/ltk: 20
• Reunakorkeus vain 4 mm • Kannen ø 143 mm

9 Neliökannet

Quality for HVAC
Technology



Merika 984



Merika 996



Muovinelikansi

Merika nro	LVI nro	EAN
981 valkoinen	3316841	6 415833 168416
982 ruskea	3316842	6 415833 168423
983 harmaa	3316843	6 415833 168430
985 beige	3316844	6 415833 168447
984 taivaansininen	3316845	6 415833 168454
980 rosa	3316846	6 415833 168461
997 vaaleanvihreä	3316847	6 415833 168478
969 tummanvihreä	3316848	6 415833 168485

- Koko: 160 × 160 mm • Paino 0,150 • Kpl/Itk: 20
- Reunakorkeus vain 4 mm • Kannen ø 143 mm

Muovinelikansi, epäkeskeinen

Merika nro	LVI nro	EAN
986 valkoinen	3316861	6 415833 168614
987 ruskea	3316862	6 415833 168621
970 harmaa	3316863	6 415833 168638
989 beige	3316864	6 415833 168645
988 taivaansininen	3316865	6 415833 168652
971 rosa	3316866	6 415833 168669
996 vaaleanvihreä	3316867	6 415833 168676
990 tummanvihreä	3316868	6 415833 168683

- Koko: 180 × 180 mm • Paino 0,210 • Kpl/Itk: 20

9 Neliökannet

Quality for HVAC
Technology



Merika 953



Muovinelökansi

Merika nro	LVI nro	EAN
950 valkoinen	3316811	6 4 15833 168119
951 ruskea	3316812	6 4 15833 168126
952 harmaa	3316813	6 4 15833 168133
953 beige	3316814	6 4 15833 168140
954 taivaansininen	3316815	6 4 15833 168157
955 rosa	3316816	6 4 15833 168164
956 vaaleanvihreä	3316817	6 4 15833 168171
957 tummanvihreä	3316818	6 4 15833 168188

- Koko: 197 × 197 mm • Paino 0,161 • Kpl/ltk: 20
- Reunakorkeus vain 4 mm • Kannen ø 143 mm

9 Neliökannet

Quality for HVAC
Technology



Neliökansi, ruostumatonta terästä

Merika nro	LVI nro	koko	paino	kp/ltk	EAN
914	3316897	197 × 197	0,307	40	6 4 15833 168973
914M hiottu	3316896	197 × 197	0,279	20	6 4 15833 168966
M914 musta		197 × 197	0,279	20	

- Reunakorkeus vain 4 mm

Neliökansi, ruostumatonta terästä, 32 mm reiällä

913	3316898	197 × 197	0,278	20	6 4 15833 168980
913M hiottu	3316809	197 × 197	0,278	20	6 4 15833 168096

- Reunakorkeus vain 4 mm

Neliökansi, ruostumatonta terästä

915	3311420	197 × 197	0,339	20	6 4 15833 114208
915M hiottu	3316819	197 × 197	0,339	20	6 4 15833 168195
M915 musta	3312416	197 × 197	0,339	20	6 4 38541 000656

- Reunakorkeus vain 4 mm • kansi 2 mm

Neliökansi, ruostumatonta terästä, 32 mm uralla

915/32	3316849	197 × 197 / 32	0,357	20	6 4 15833 168492
915/32/M hiottu	3316820	197 × 197 / 32	0,357	20	6 4 15833 168201

- Reunakorkeus vain 4 mm • kansi 2 mm

9 Neliökannet

Quality for HVAC
Technology



Ruostumaton kansi, asennuskehys muovia

Merika nro	LVI nro	koko	paino	kpl	EAN
912	3316881	160 × 160	0,523	20	6 4 15833 168812
912/32	3316882	160 × 160/32	0,512	20	6 4 15833 168829

• Kansi 3 mm ruostumatonta terästä • Asennuskehys muovia • Reunakorkeus 7 mm

Neliökansi, ruostumatonta terästä

917	3316895	197 × 197	0,657	20	6 4 15833 168959
M917 musta		197x197	0,657	20	
918*	3316899	197 × 197	0,624	20	6 4 15833 168997

• Reunakorkeus 7 mm, kansi 3 mm

*) 32 mm reiällä

Neliökansi, ruostumatonta terästä

919	3316894	197 × 197	0,646	20	6 4 15833 168942
-----	---------	-----------	-------	----	------------------

• Reunakorkeus 7 mm, kansi 3 mm • Ruuvilukittavalla kannella

Neliökansi, ruostumatonta terästä, epäkeskeinen

916	3316888	197 × 197	0,864	20	6 4 15833 168881
9161*	3311415	197 × 197	0,835	20	6 4 15833 114154

• Reunakorkeus 6,5 mm, kansi 3 mm • Epäkeskeinen muovikehys • ±15/±7,5 mm, RST-kansi

*) 32 mm reiällä

9 Neliökannet

Quality for HVAC
Technology



Neliökansi, ruostumatonta terästä

Merika nro	LVI nro	koko	paino	kpl	EAN
9171	3316829	197 × 197	0,645	1	6 4 15833 168294
9172	3316830	197 × 197	0,635	1	6 4 15833 168300
9173	3316831	197 × 197	0,666	1	6 4 15833 168317
9174	3316832	197 × 197	0,653	1	6 4 15833 168324
9175	3316833	197 × 197	0,675	1	6 4 15833 168331
9176	3316834	197 × 197	0,677	1	6 4 15833 168348

• Reunakorkeus 7 mm, kansi 3 mm

9 Neliökannet

Quality for HVAC
Technology



PH-KAIVOILLE Ruostumaton kansi, asennuskehys muovia

Merika nro	LVI nro	koko	paino	kpl	EAN
911	3316893	297 × 297	1,900	1	6 4 15833 168935
911/32	3316889	297 × 297/32	1,894	1	6 4 15833 168898
911/50	3316890	297 × 297/50	1,874	1	6 4 15833 168904

• Kansi 3 mm ruostumatonta terästä • Asennuskehys muovia • Reunakorkeus 8 mm

9 Neliökannet

Quality for HVAC
Technology



Neliökansien varaosat

Merika nro	LVI nro	kuvaus	paino	EAN
430		RST-kansi PH-kaivolle • 290 × 290 • 3 mm	1,670	
430/U umpikansi		RST-kansi PH-kaivolle • 288 × 288 • 3 mm	1,958	
430/32		RST-kansi PH-kaivolle • 290 × 290 • 32 mm reiällä • 3 mm	1,667	
430/50		RST-kansi PH-kaivolle • 290 × 290 • 50 mm reiällä • 3 mm	1,647	
437	3315733	RST-kansi • ø 150 • 1 mm	0,125	6 4 15833 1157335
437M hiottu		RST-kansi • ø 150 • 1 mm	0,123	
M437 musta		RST-kansi • ø 150 • 1 mm	0,125	
437_02	3315734	RST-kansi • ø 150 • 32 mm reiällä • 1 mm	0,122	6 4 15833 1157342
437_04	3311421	RST-kansi • ø 150 • suorakaidereiät • 2 mm	0,205	6 4 15833 1114215
437_05	3311434	RST-kansi • ø 150 • suorakaidereiät 32 mm uralla • 2 mm	0,205	6 4 15833 1114345
437_06 hiottu	3311435	RST-kansi • ø 150 • suorakaidereiät • 2 mm	0,122	6 4 15833 1114352
437_07 hiottu	3311436	RST-kansi • ø 150 • suorakaidereiät 32 mm uralla • 2 mm	0,205	6 4 15833 1114369
437/32/U		RST-kansi • ø 150 • 32 mm uralla • 1 mm	0,119	
437/32/U/M hiottu		RST-kansi • ø 150 • 32 mm uralla • 1 mm	0,119	

9 Neliökannet

Quality for HVAC
Technology



Neliökansien varaosat				
Merika nro	LVI nro	kuvaus	paino	EAN
438		RST-kansi • 156 × 156 • 3 mm	0,452	
M438		RST-kansi • 156 × 156 • 3 mm	0,452	
438_02		RST-kansi • 156 × 156 • 32 mm reiällä • 3 mm	0,443	
438_03		RST-kansi • 156 × 156 • 32 mm uralla • 3 mm	0,426	
4381	3316835	RST-kansi • 156 × 156 • 3 mm	0,475	6 4 15833 168355
4382	3316836	RST-kansi 156 × 156 • 3 mm	0,475	6 4 15833 168362
4383	3316837	RST-kansi 156 × 156 • 3 mm	0,504	6 4 15833 168379
4384	3316838	RST-kansi 156 × 156 • 3 mm	0,491	6 4 15833 168386
4385	3316839	RST-kansi 156 × 156 • 3 mm	0,516	6 4 15833 168393
4386	3316840	RST-kansi 156 × 156 • 3 mm	0,517	6 4 15833 168409
439_011		Lukitusrautasarja RST-kanteen 439	0,016	
916_01	3311441	RST-kansi 189 × 189 • 3 mm	0,754	6 438541 000502

10 Vesilukkoputken tiivisteet

Quality for HVAC
Technology



MERIKA[®] HK-tiiviste[®]



10 Vesilukkoputken tiivisteet

Quality for HVAC
Technology

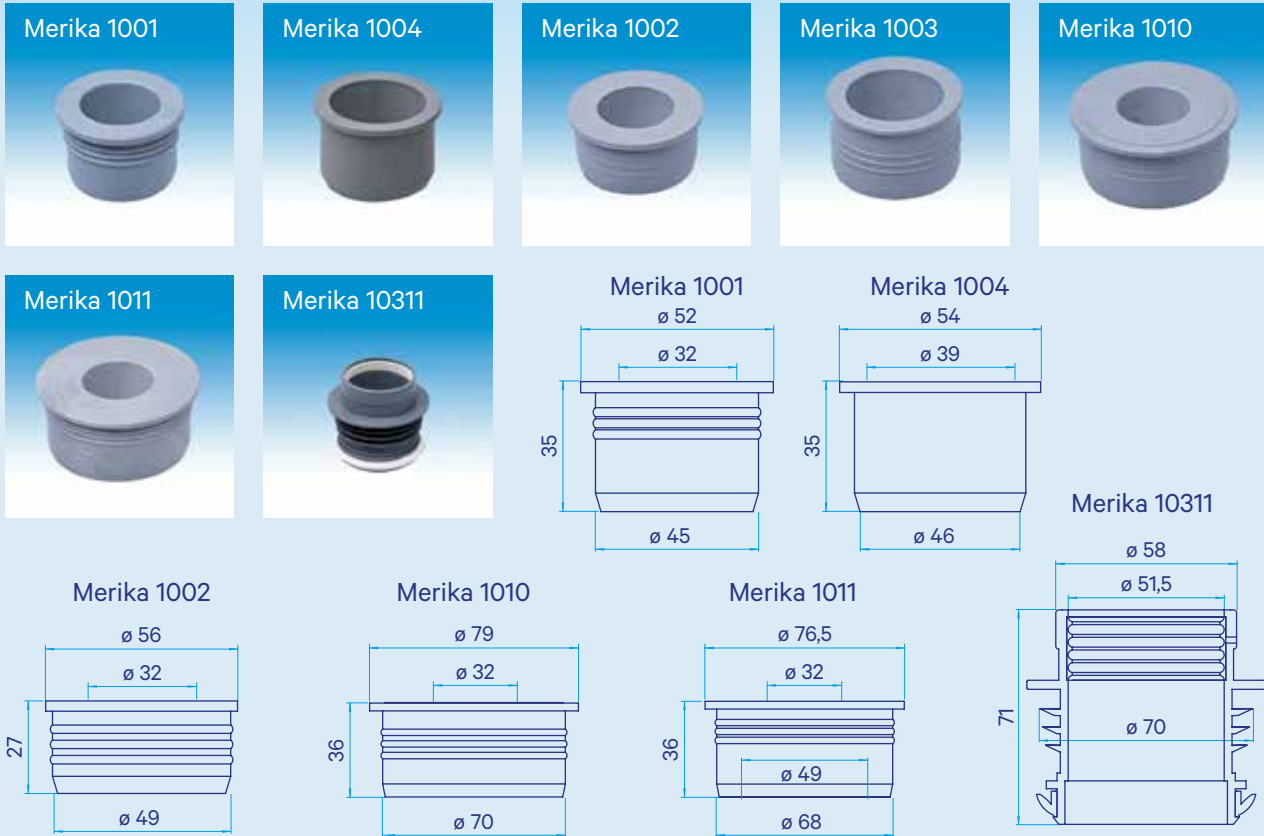

HK-tiiviste sopii PP- ja PVC-putkille

Merika nro	LVI nro	koko	paino	kpl (ltk/lava)	EAN
1001	2376053	50/30	0,021	30/2430	6 4 15823 760538
1004	2376054	50/40	0,017	30/2430	6 4 15823 760545

HK-muhvitiiviste

1002	2376063	55/30	0,025	30/1050	6 4 15823 760637
1003	2376064	55/40	0,035	20	6 4 15823 760644

HK-tiiviste sopii PP- ja PVC-putkille

1010	2376072	70/30	0,050	20/1620	6 4 15823 760729
------	---------	-------	-------	---------	------------------

HK-tiiviste sopii kahdelle putkikoolle sekä PVC- ja valurautaputkille

1011	2376073	70/30-50	0,040	30/1050	6 4 15823 760736
------	---------	----------	-------	---------	------------------

HK-tiivistemuhvi vesilukkoputkelle

10311	2362132	70/50	0,046	20	6 4 15823 621327
-------	---------	-------	-------	----	------------------

10 Vesilukkoputken tiivisteet

Quality for HVAC
Technology



Merika 1021

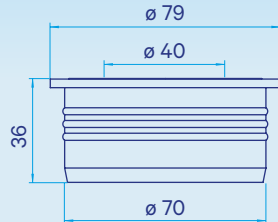

Merika 1021



Merika 1054

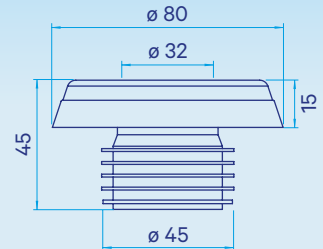

Merika 1054



Merika 1031

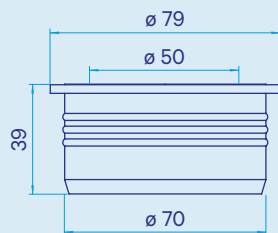

Merika 1031



Merika 1061

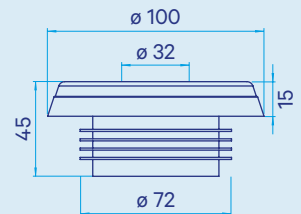

Merika 1061



Merika 1041

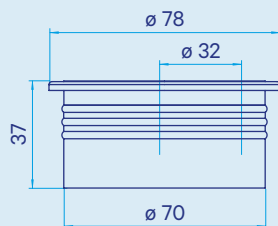

Merika 1041



Merika 1063

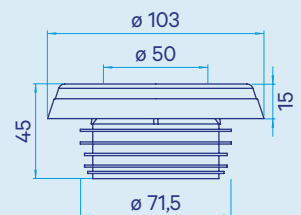

Merika 1063

HK-tiiviste

Merika nro	LVI nro	koko	paino	kpl (ltk/lava)	EAN
1021	2376074	70/40	0,060	30	6 415823 760743
1031	2376075	70/50	0,035	20/1620	6 415823 760750
1041 epäkesk.	2376081	70/30 EK	0,035	20	6 415823 760811

HK-tiiviste peitelapalla valkoinen

● 1054	2362131	50/30	0,025	30/2430	6 415823 621310
○ 1061	2362133	70/30	0,045	30/1620	6 415823 621334
○ 1063	2362135	70/50	0,040	30/1620	6 415823 621358

● sopii PP-putkille ○ sopii PP-, PVC- ja valurautaputkille

10 Vesilukkoputken tiivisteet

Quality for HVAC
Technology

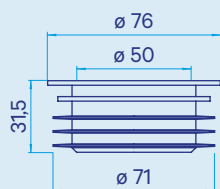

Merika 1071

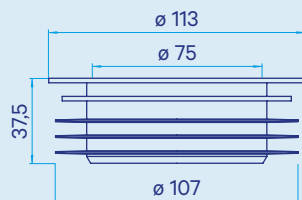

Merika 1081

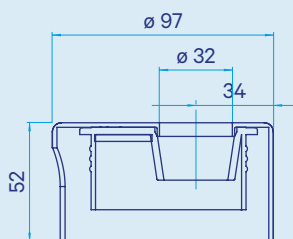

Merika 1091

HK-tiiviste muovia

Merika nro	LVI nro	koko	paino	kpl (ltk/lava)	EAN
1071	2363012	70/50	0,020	20	6 4 15823 63012 1
1081	2363014	100/75	0,049	10	6 4 15823 63014 5
1081M musta		100/75	0,049	10	

HK-tiiviste epäkesk. + peitelaippa epäkesk. kromattua muovia

1091	2363283	70/30 EK	0,075	10	6 4 15823 63283 5
------	---------	----------	-------	----	-------------------

11 Vesilukot ja tarvikkeet

Quality for HVAC
Technology



MERIKA®



11 Vesilukot ja tarvikkeet

Quality for HVAC
Technology



Huom!

Vesilukon virtaamavaatimus on 0,3 dm³/s.
Merika 2131 vesilukossa virtaama on 0,7 dm³/s.

Muovivesilukko, lattiaputkin, pohjaventtiilein virtaama 0,7 dm³/s

Merika nro	LVI nro	koko	paino	kpl	EAN
2131	6502831	NS 32	0,379	10	6 4 15865 028313

Muovivesilukko 32 mm

1935	6502834	NS 32	0,293	25	6 4 15865 028344
------	---------	-------	-------	----	------------------

Muovivesilukko tilaa säästävä, lattiaputkin 32 mm

1936		NS 32		25	
------	--	-------	--	----	--

Kartiotiiviste

1945	5975192	32	0,002	20 kpl/pss 200 kpl/ltk	6 4 15859 751920
1946	5975193	40	0,001	100	6 4 15859 751937
1947	5975194	50	0,003	100	6 4 15859 751944

Vesilukkoputken kannakointipidin, säädettävä

10001	3226205	ø 57 mm	0,045	20	6 4 15832 262054
10002	3226207	ø 27–32 mm	0,061	20	6 4 15832 262078

11 Vesilukot ja tarvikkeet

Quality for HVAC
Technology



Pohjaventtiili ammeelle muovia

Merika nro	LVI nro	kuvaus	paino	EAN
1942	6502246	Pohjaventtiili ammeelle, 32 mm muovia	0,083	6 4 15865 022465
1943	5975232	Pohjaventtiili ja putki ammeelle 32 mm	0,283	6 4 15859 752323

Muunnosnipa

Merika nro	LVI nro	koko	paino	kpl	EAN
2444 muovia	5975171	1 ½ – 1 ¼	0,022	10	6 4 15859 751715
2445 messinkiä, krom.	5975172	1 ½ – 1 ¼	0,088	10	6 4 15859 751722

Peitelaippa vesilukkoputkelle sopii myös 75 HT-muhvin päälle

1231 kromattu	6502197	95/32 × 40	0,036	100	6 4 15865 021970
1232 valkoinen	6502198	95/32 × 40	0,035	50	6 4 15865 021987

Peitelaippa vesilukkoputkelle, epäkeskeinen

1241 kromattu	6502187	95/32 × 50	0,042	1	6 4 15865 021871
1242 valkoinen	6502188	95/32 × 50	0,045	1	6 4 15865 021888
B1242 musta		95/32 × 50	0,045	1	

11 Vesilukot ja tarvikkeet

Quality for HVAC
Technology



Viemärinavaajapumppu

Merika nro	LVI nro	koko	paino	kpl	EAN
1341	7014402		0,326	20	6 4 15870 144022

Hanatiivisteet

1351 palko	3263332	15	0,001	100	6 4 15832 633328
1352 palko	3263334	16	0,001	100	6 4 15832 633342
1361 sileä	3263342	15	0,001	100	6 4 15832 633427
1362 sileä	3263344	16	0,001	100	6 4 15832 633441

Tiivistesarja

1370	3263811		0,012	10	6 4 15832 638118
------	---------	--	-------	----	------------------

- sisältää 8 kpl NS 15 ja 6 kpl NS 20 sauger-tiivisteitä

11 Vesilukot ja tarvikkeet

Quality for HVAC
Technology



Allastulppa					
Merika nro	LVI nro	koko	paino	kpl	EAN
1311	5978971	38	0,011	20	6 4 15859 789718
1312	5978973	40	0,011	20	6 4 15859 789732
1313	5978975	42	0,011	20	6 4 15859 789756
1314	5978977	43	0,011	20	6 4 15859 789770
1315	5978979	45	0,011	20	6 4 15859 789794
1317	5978980	Sopii Stala/ Hackman -altaisiin	0,011	20	6 4 15859 789800
1318	5978981	Yleismalli	0,015	20	6 4 15859 789817

11 Vesilukot ja tarvikkeet

Quality for HVAC
Technology



Merika 2922



Merika 2923



Merika 2424



Merika 2425



Merika 2484



Merika 2483



Allassihti, muovia

Merika nro	LVI nro	koko	paino	kpl	EAN
2922 musta			0,012	2	
2923 valkoinen	5975161		0,012	2	6 4 15859 751616

Poresuutin, sisäkierre

2424	6502850	M 22 × 1"	0,014	10	6 4 15865 028504
-------------	---------	-----------	-------	----	------------------

Poresuutin, ulkokierre

2425	6502860	M 24 × 1"	0,014	10	6 4 15865 028603
2484	6502880	M 28 × 1"	0,021	10	6 4 15865 028801

Poresuutin, säädettävä

2483	6502855	22/24	0,049	10	6 4 15865 028559
-------------	---------	-------	-------	----	------------------

12 WC-liitosyhteet ja tarvikkeet

Quality for HVAC
Technology



MERIKA®



12 WC-liitosyhteet ja tarvikkeet

Quality for HVAC
Technology



WC-mansetti

Merika nro	LVI nro	koko	paino	kpl (ltk/lava)	EAN
1111	5688504	NS 100	0,250	30/600	6 4 15856 885048
• väri valkoinen • sopii 110 mm HT- ja valurautaputkeen • siirto 15 mm					
1112	5688506	NS 100	0,193	40	6 4 15856 885062
• väri valkoinen • sopii 110 mm HT- ja valurautaputkeen • siirto 15 mm					
11115	5758265	NS 100	0,201	10	6 4 15857 582656
• sopii 110 mm HT- ja valurautaputkeen • siirto 38 mm					

Sopivat myös 90 mm viemäreille ja vesieristyslattioihin. **Huom!** Mansetilla voidaan jatkaa mansettia.



WC-mansetti tuloputkella

11112	5758262	NS 100	0,208	10	6 4 15857 582625
• 32 mm tuloputki • sopii 110 mm HT- ja valurautaputkeen • siirto 38 mm					
11113	5758263	NS 100	0,215	10	6 4 15857 582632
• 40 mm tuloputki • sopii 110 mm HT- ja valurautaputkeen • siirto 38 mm					
11114	5758264	NS 100	0,220	10	6 4 15857 582649
• 50 mm tuloputki • sopii 110 mm HT- ja valurautaputkeen • siirto 38 mm					

WC-mansetin peitemuhvi

1111_02					
• sopii WC-mansetteihin M-1111 ja M-1112					
111121	5758266		0,043		6 4 15857 582663
• 32 tuloputkelle • sopii WC-mansettiin M-1112					
111141	5758268		0,040		6 4 15857 582687
• 40 ja 50 tuloputkelle • sopii WC-mansetteihin M-11113 ja M-11114					
111151	5758269		0,043		6 4 15857 582694
• sopii WC-mansettiin M-11115					

12 WC-liitosyhteet ja tarvikkeet

Quality for HVAC
Technology



Q-lukko 110 mm					
Merika nro	LVI nro	koko	paino	kpl (ltk/lava)	EAN
1125	5758261	110	0,384	10	6 415857 582618
1126 *vasen	5758271	110/50	0,414	10	6 415857 582717
1127 *oikea	5758281	110/50	0,414	10	6 415857 582816
1128 oikea, pitkä malli	5758270	110/50	0,475	10	6 438541 000588

* 50 mm lisäyhde esim. alipaineventtiiliä varten

WC-yhteen tiiviste					
1131	5688511	110 yhdysputkelle	0,129	20	6 415856 885116
1132	5688512	110 muhvi	0,080	20	6 415856 885123

WC-liitostiiviste valurautaputkelle, sopii 110 mm valurautaputken muhvin päälle					
1141	5688510	NS 100	0,193	20	6 415856 885109

12 WC-liitosyhteet ja tarvikkeet

Quality for HVAC
Technology



WC-jalan suojatulppa

Merika nro	LVI nro	koko	paino	kpl	EAN
1531 valkoinen	3255482		0,081	100/pss	6 4 15832 55482 1
1532 valkoinen	3255481		0,005	4/pss 200 pss/ltk	6 4 15832 55481 4

WC-yhteiden peitemuhvi, muovia

kpl/lava

1251 valkoinen	5688601		0,075	5/100	2500	6 4 15856 88601 4
--------------------------	---------	--	-------	-------	------	-------------------

- jälkiasennettava • sopii myös valurautaputken muhvin päälle

WC-kumimuhvi

1321	5688011	38–40	0,098	10		6 4 15856 88011 1
-------------	---------	-------	-------	----	--	-------------------

Pallero WC-lastenistuim

531 valkoinen	5710017		0,255	10/20		6 4 15857 10017 1
-------------------------	---------	--	-------	-------	--	-------------------

Kan ulko-WC:n lämpöistuim

860	5710026		0,160	12		6 4 15857 10026 3
------------	---------	--	-------	----	--	-------------------

13 Työtulpat

Quality for HVAC
Technology



MERIKA®



13 Työtulpat

Quality for HVAC
Technology



JS-työtulppa

Merika nro	LVI nro	koko	paino	kpl (ltk/lava)	EAN
1201	2375075	75/50	0,082	150/3750	6 4 15823 750751
1202	2375107	110/75/50	0,150	50/1250	6 4 15823 751079
1216	2375110	200/160	0,258	15/375	6 4 15823 751109

- sopii HTP-putken muhviin ja HTP-putken päälle sekä valurautaputkelle

Työtulppa

1210	2373503	32/28	0,007	50	6 4 15823 735031
1211	2373505	50	0,017	50/1350	6 4 15823 735055
1212	2373507	75	0,025	50/1350	6 4 15823 735079
1213	2373511	110	0,042	100/2500	6 4 15823 735116
1214	2373516	160	0,106	30/750	6 4 15823 735161

- sopii HTP-putken muhviin ja HT-putken sisään

13 Työtulpat

Quality for HVAC
Technology



Esa-työtulppa

Merika nro	LVI nro	koko	paino	kpl	EAN
1219	2373521	75/50	0,017	50	6 415823 735215
1220	2373524	110/75	0,027	50	6 415823 735246

- sopii HT-putken muhviin ja HT-putken sisään sekä HT-putken päälle

Suojatulppa

Merika nro	kuvaus	koko	paino
1797	Merika suojatulppa SO- ja SV-kaivolle	110	0,073
1225	Merika IV-putken työtulppa	125	0,060

- sopii seinämävahvuksiltaan erilaisille putkille, valurautaputkille, PP-putkille, PVC-putkille, tuplaputkille ja IV-putkille

14 Putkipitimet muoviva

Quality for HVAC
Technology



MERIKA®

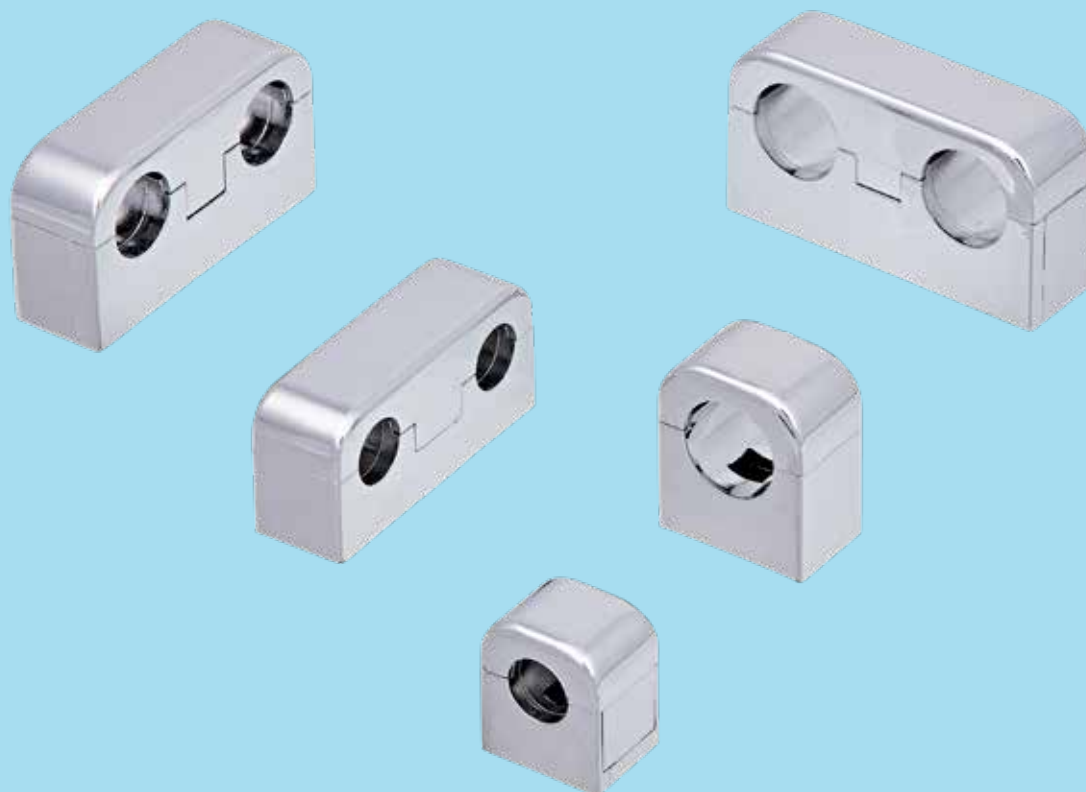

14 Putkipitimet muovia

Quality for HVAC
Technology



Elviira-putkipidin

Merika nro	LVI nro	koko	paino	kpl	EAN
1441K kromattu	3225453	12 × 1	0,004	25	6 4 15832 254530
1442K kromattu	3225454	15 × 1	0,006	25	6 4 15832 254547
14421K kromattu	3226215	16 × 1	0,006	25	6 4 38541 000311
1443K kromattu	3225455	18 × 1	0,006	25	6 4 15832 254554
1436K kromattu	3225433	12 × 2	0,010	25	6 4 15832 254332
1437K kromattu	3225434	15 × 2	0,012	25	6 4 15832 254349
14371K kromattu	3226217	16 × 2	0,012	25	6 4 38541 000298
1438K kromattu	3225435	18 × 2	0,012	25	6 4 15832 254356



Asennus: Pidin asennetaan seinään. Se voidaan kannakoida myös M4-ruuvilla. Tämän jälkeen asennetaan putki, joka lukitaan salvalla pidikkeeseen. Lopuksi asennetaan kansi päälle.

Avaus: Kansi poistetaan. Sopiva ruuvimeisseli työnnetään salvan sisäänmenoaukon ulkoreunaan ja vedetään samalla putkesta.

14 Putkipitimet muovia

Quality for HVAC
Technology



Yksiosainen putkipidin, valkoinen

Merika nro	LVI nro	koko	paino	kpl	EAN
1401	3226204	8 × 1	0,003	24	6 4 15832 262047
1402	3226206	10 × 1	0,003	24	6 4 15832 262061
1403	3226208	12 × 1	0,004	24	6 4 15832 262085
1404	3226210	15 × 1	0,004	24	6 4 15832 262108
1405	3226212	18 × 1	0,005	24	6 4 15832 262122
1406	3226214	22 × 1	0,005	24	6 4 15832 262146
1407	3226216	28 × 1	0,007	24	6 4 15832 262160

Kaksiosainen putkipidin, valkoinen

1412	3226256	10 × 2	0,007	24	6 4 15832 262566
1413	3226258	12 × 2	0,009	24	6 4 15832 262580
1414	3226260	15 × 2	0,009	24	6 4 15832 262603
1415	3226262	18 × 2	0,009	24	6 4 15832 262627
1416	3226264	22 × 2	0,012	24	6 4 15832 262641
1417	3226266	28 × 2	0,014	24	6 4 15832 262665

14 Putkipitimet muovia

Quality for HVAC
Technology



Yksiosainen putkipidin

Merika nro	LVI nro	koko	paino	kpl	EAN
1408 valkoinen	2373323	32 × 1	0,012	30/300 pss/ltk	6 4 15823 733235
B1408 musta		32 × 1	0,012	30/300 pss/ltk	
1410 kromattu	2373313	32 × 1	0,012	25	6 4 15823 733136

Yksiosaisen 32 mm putkipitimen korokepala

1408_03 valkoinen			0,003	100	
1410_03 kromattu			0,003	100	

Suojaputken pidin

1400 valkoinen	3226236	24–28	0,003	25	6 4 15832 262368
1396 valkoinen	3226227	25 mm/1-os	0,003	24	6 4 15832 262276
1397 valkoinen	3226228	25 mm/2-os	0,004	24	6 4 15832 262283
1398 valkoinen	3226229	28 mm/1-os	0,004	24	6 4 15832 262290
1399 valkoinen	3226230	28 mm/2-os	0,004	24	6 4 15832 262306

15 Sadevesikaivot ja salaojakaivot

Quality for HVAC
Technology



MERIKA®



15 Sadevesikaivot ja salaojakaivot

Quality for HVAC
Technology



Sadevesikaivot					
	Merika nro	LVI nro	paino	kpl ltk/lava	EAN
Elegance • 110 mm poistolla • Reilu ø 310 mm roiskekansi • Vesitiivis liitos • Saatavana lisäyhteitä ja korotusrenkaita	1790RS	2606020	1,355 kg	4/72	6 415826 060208
AvantGarde • Sopii 110 mm poistoputkelle ja 315 mm kerääjäkaivolle • Reilu ø 310 mm roiskekansi • 110 mm poisto, epäkeskeinen heitto ±50 mm	1780RS	2606018	1,367 kg	8/144	6 415826 060185
Classic • Roiskesuojalla varustettu • Alahelman ansiosta kaivo pysyy tukevasti paikoillaan • Sopii 110 mm tupla-/sileälle putkelle sekä 315 mm kerääjäkaivolle • 110 mm muhussa vesitiivis liitos tippareunan ansiosta	1770RS	2606352	0,747 kg	6/150	6 415826 063520
Muhee • Helppo liittää myös pihalaatoituksen yhteyteen • Varustettu roiskesuojalla • Pitkä alahelma pitää kaivon tukevasti paikoillaan • Sopii 110 mm tupla-/sileälle putkelle sekä 315 mm kerääjäkaivolle • 110 mm muhussa vesitiivis liitos tippareunan ansiosta	1760RS	2606361	1,346 kg	4/100	6 415826 063612
Grande • Hartiapankkirakentajan edullinen vaihtoehto • Syväaltainen, suuri vesitila ehkäisee tulvimista • Tehokas neulasten ja lehtien suodatus • 110 mm epäkeskeinen muhvilleitos	1769	2606357	0,534 kg	-/180	6 415826 063575
Grande Plus • Rakentajan varma sadevesikaivoratkaisu • Suuri vesitila ehkäisee tulvimista. Plus-roiskesuoja voidaan kääntää haluttuun asentoon • Tehokas neulasten ja lehtien suodatus • 110 mm epäkeskeinen tippareunallinen muhvilleitos	1769/PLUS	2606005	0,731 kg		6 415826 060055

15 Sadevesikaivot ja salaojakaivot

Quality for HVAC
Technology



Osat ja tarvikkeet				
tuotetiedot	Merika nro	LVI nro	paino	EAN
Välirengas hyötykorkeus 140 mm	1700	2606021	0,321	6 415826 060215
Välirengas hyötykorkeus 90 mm	1700M	2606022	0,217	6 415826 060222
Väliyhde ø 110 mm, hyötykorkeus 140 mm	1702	2606027	0,370	6 415826 060277
Väliyhde, läpimenevä 110/110 mm	1789	2606033	0,402	6 415826 060338
Pohjayhde 110 mm, hyötykorkeus 140 mm	1704	2606043	0,451	6 415826 060437
Pohja ilman poistoa, hyötykorkeus 140 mm	1705	2606051	0,414	6 415826 060512
Roiskekansi ø 310 mm	1740	2606058	0,543	6 415826 060581
Sadevesikansi ø 310 mm	1741	2606071	0,265	6 415826 060710
Suppilo kaivoon, hyötykorkeus 90 mm	1742	2606076	0,327	6 415826 060765
NS 65/75 liitosyhde	1765	2606102	0,047	6 415826 061021
NS 80/110 liitosyhde	1766	2606103	0,078	6 415826 061038

Jatkuu seuraavalla sivulla

15 Sadevesikaivot ja salaojakaivot

Quality for HVAC
Technology



Osat ja tarvikkeet				
tuotetiedot	Merika nro	LVI nro	paino	EAN
Jäätymistä ehkäisevä läppä	1768	2606081	0,114	6 4 15826 060819
Pohjayhde, läpimenevä 110/110 mm	1778	2606048	0,497	6 4 15826 060482
Pohjayhde, läpimenevä 110/110 mm 3-tie	1778_01	2606049	0,587	6 4 15826 060499
Väliyhde, läpimenevä 110/110 mm 3-tie	1791	2606067	0,650	6 4 15826 060673
Jäätymissuoja sadevesi-/salaojakaivolle, 290 mm	1795_02		1,109	
Roiskesuoja Grande-kaivoon	PLUS	2606059	0,197	6 4 15826 060598

15 Sadevesikaivot ja salaojakaivot

Quality for HVAC
Technology



Sadevesikaivot sakkapesällä

tuotetiedot	Merika nro	LVI nro	paino	EAN
SV-kaivo sakkapesällä • Muhee-suppilolla • 110 mm	1794	2606356	7,590 kg	6 415826 063568
SV-kaivo sakkapesällä • Classic-suppilolla • 110 mm	1796	2606354	7,140 kg	6 415826 063544
SV-kaivo sakkapesällä, säädettävä • ritiläkansi 41331 • 315/200/110 • kantavuus 1,5 tn	17958	2606312	12 kg	6 415826 063124
SV-kaivo sakkapesällä • ritiläkansi 41322 • 110/315/450 • kantavuus 2 tn	17953	2606007	10,550 kg	6 415826 060079

15 Sadevesikaivot ja salaojakaivot

Quality for HVAC
Technology



Salaojakaivot sakkapesällä

tuotetiedot	Merika nro	LVI nro	paino	kpl /lava	EAN
Salaojakaivo • 315/110 • suojahattu • muhvikoko 110 • korkeus 1000 mm	1795	2606311	5,8 kg	12	6 415826 063117
Salaojakaivo • 315/110 • suojahattu • muhvikoko 110 • korkeus 1500 mm	17955	2606011	10,2 kg	12	6 415826 060116
Salaojakaivo • 315/200/110 • säädettävä 1100/1600 mm • umpikansi 4133 • kantavuus 5 tn	17956	2606012	12 kg	12	6 415826 060123
Salaojakaivo • umpikansi 4132 • 110/315/450 • korkeus 1000 mm • kantavuus 5 tn	17952	2606006	3,960 kg		6 415826 060062
Salaojakaivo • umpikansi 4135 • 110/315/350 • korkeus 1000 mm • kantavuus 1,5 tn	17954	2606010	8,043 kg		6 415826 060109
Salaojakaivo • 315/200/110 • säädettävä 1100/1600 mm • valurautakansisto • kantavuus 40 tn	17957	2606029	12 kg		6 415826 060291
Salaoja-/sadevesikaivo, pitkä • 3 m • 315/110 • suojahattu • muhvikoko 110 • korkeus 3000 mm	17951	2606016	18,970 kg		6 415826 060161
Teleskooppipaketti • 315/200 • sisältää teleskooppiputken ja -renkaan sekä muovikansiston 4133 • kantavuus 5 tn • korkeus 700 mm	179561		5,680 kg		
Teleskooppipaketti • 315/200 • sisältää teleskooppiputken, -renkaan ja valurautaisen umpikansiston • kantavuus 40 tn • korkeus 700 mm	179562		5,680 kg		

Salaojakaivot 200 mm sakkapesällä.

15 Sadevesikaivot ja salaojakaivot

Quality for HVAC
Technology



Kunnallistekniset kaivot

tuotetiedot	Merika nro	LVI nro	paino	EAN
PVKM 500/315 muoviumpikansistolla • 5 tn	PVKM500315		36,982	
PVKV 500/315 valurautaumpikansistolla • 40 tn	PVKV500315		67,305	
SVKM 500/315 muoviritiläkansistolla • 5 tn	SVKM500315		35,429	
SVKV 500/315 valurautarituläkansistolla • 40 tn	SVKV500315		65,686	

15 Sadevesikaivot ja salaojakaivot

Quality for HVAC
Technology



Tarkastuskaivopakettit

tuotetiedot	Merika nro	LVI nro	paino	EAN
Merika PRO tarkastusk.pkt. 400/315/110 Suora 110 mm	MP34100	2606032	59	6 4 15826 06032 1
Merika PRO tarkastusk.pkt. 400/315/160 Suora 160 mm	MP34130	2606036	60	6 4 15826 06036 9
Merika PRO tarkastusk.pkt. 400/315/200 Suora 200 mm	MP34215	2606037	60	6 4 15826 06037 6
Merika PRO tarkastusk.pkt. 400/315/110 Risteävä 110 mm	MP34110	2606034	59,5	6 4 15826 06034 5
Merika PRO tarkastusk.pkt. 400/315/160 Risteävä 160 mm	MP34115	2606035	61,5	6 4 15826 06035 2
Merika PRO tarkastusk.pkt. 400/315/200 Risteävä 200 mm	MP34200	2606038	63	6 4 15826 06038 3

Tarkastuskaivon pohjaosa

Pro kaivon pohjaosa suora 400/110 mm	M34100		2,71	
Pro kaivon pohjaosa suora 400/160 mm	M34130		4,28	
Pro kaivon pohjaosa suora 400/200 mm	M34215		4,23	
Pro kaivon pohjaosa risteävä 400/110 mm, 3 tuloa	M34110		3,21	
Pro kaivon pohjaosa risteävä 400/160 mm, 3 tuloa	M34115		5,03	
Pro kaivon pohjaosa risteävä 400/200 mm, 3 tuloa	M34200		8,80	

15 Sadevesikaivot ja salaojakaivot

Quality for HVAC
Technology



Taivutuskulma ja haara

tuotetiedot	Merika nro	LVI nro	paino	EAN
Taivutuskulma PEH 110 mm/0–90° 80 kpl/ltk	1792	2527422	0,257	6 415825 274224
Taipuisa PEH T-haara 110 mm/0–60° 60 kpl/ltk	1793	2527432	0,317	6 415825 274323

Sadevesi- ja salaojaputket

Salaojaputki PE SN8 110x6000 TP	2519327	2527421		6 415825 274217
Sadevesiputki PE SN8 110x6000	2513127	2527420		6 415825 274200

saatavana myös muita kokoja

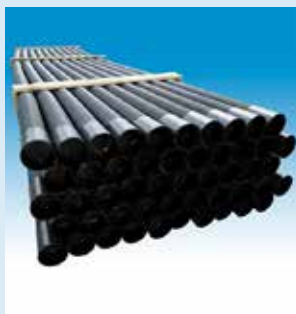

16 PP-osat ja putket

Quality for HVAC
Technology



MERIKA®



16 PP-osat ja putket



Quality for HVAC
Technology



Merika kulmayhteet 15°

Merika nro	LVI nro	koko	paino	harm.	valk.	krom.	kpl (ltk/lava)	EAN
2128	2449401	32	0,020		●		10	6 415824 494012
2147	2449801	32	0,020			●	10	6 415824 498010
2160	2430003	50	0,038	●			25/1750	6 415895 031239
2160V	2449402	50	0,038		●		25/1750	6 415824 494029
2161	2430004	75	0,078	●			20/980	6 415895 031246
2162	2430006	110	0,184	●			25/600	6 415895 031253

Merika kulmayhteet 30°

2130	2449411	32	0,020		●		10	6 415824 494111
2146	2449803	32	0,022			●	10	6 415824 498034
2163	2430013	50	0,039	●			25/875	6 415895 031260
2163V	2449412	50	0,039		●		25/875	6 415824 494128
2164	2430014	75	0,083	●			20/980	6 415895 031277
2165	2430016	110	0,200	●			25/600	6 415895 031284

16 PP-osat ja putket

Quality for HVAC
Technology



Merika kulmayhteet 45°

Merika nro	LVI nro	koko	paino	harm.	valk.	krom.	kpl (ltk/lava)	EAN
2140	2449421	32	0,022		●		10	6 4 15824 494210
2145	2449821	32	0,020			●	10	6 4 15824 498218
2166	2430023	50	0,041	●			25/700	6 4 15895 031291
2166V	2449422	50	0,048		●		25/700	6 4 15824 494227
2167	2430024	75	0,089	●			20/980	6 4 15895 031307
2168	2430026	110	0,219	●			20/480	6 4 15895 031314

Merika kulmayhteet 88,5°

2129	2449441	32	0,023		●		10	6 4 15824 494418
21291	2449442	32 /pyör.	0,031		●		10	6 4 15824 494425
21292	2449842	32 /pyör.	0,033			●	10	6 4 15824 498423
2144	2449841	32	0,023			●	10	6 4 15824 498416
2169	2430043	50	0,047	●			20/560	6 4 15895 031321
2169V	2449644	50	0,046		●		20/560	6 4 15824 496443
21691	2430143	50 /pyör.	0,046	●			15/525	6 4 15895 154846
21691V	2449647	50 /pyör.	0,046		●		15/525	6 4 15824 496474
2170	2430044	75	0,103	●			15/735	6 4 15895 031338
2157	2430144	75 /pyör.	0,138	●			30/720	6 4 15895 120544
2171	2430046	110	0,253	●			15/360	6 4 15895 031345
2158	2430146	110 /pyör.	0,336	●			13/312	6 4 15895 110132

16 PP-osat ja putket



Quality for HVAC
Technology



Merika muhvikulmayhteet 15°

Merika nro	LVI nro	koko	paino	harm.	valk.	krom.	kpl (ltk/lava)	EAN
2127	2449601	32	0,022		●		10	6 415824 496016
2137	2449901	32	0,022			●	10	6 415824 499017
21601	2430203	50	0,043	●			25/1750	6 415895 138105
21601V	2449602	50	0,043		●		25/1750	6 415824 496023
21611	2430204	75	0,099	●			20/980	6 415895 000808
21621	2430206	110	0,212	●			25/600	6 415895 001492

Merika muhvikulmayhteet 30°

2126	2449611	32	0,022		●		10	6 415824 496115
2136	2449911	32	0,022			●	10	6 415824 499116
21631	2430213	50	0,043	●			25/1750	6 415895 134251
21631V	2449612	50	0,043		●		25/1750	6 415824 496122
21641	2430214	75	0,103	●			20/980	6 415895 000815
21651	2430216	110	0,230	●			25/600	6 415895 001485

16 PP-osat ja putket

Quality for HVAC
Technology



Merika muhvikulmayhteet 45°

Merika nro	LVI nro	koko	paino	harm.	valk.	krom.	kpl (ltk/lava)	EAN
2125	2449621	32	0,022		●		10	6 4 15824 496214
2135	2449921	32	0,022			●	10	6 4 15824 499215
2172	2430223	50	0,043	●			25/700	6 4 15895 031352
2172V	2449622	50	0,046		●		25/700	6 4 15824 496221
2173	2430224	75	0,106	●			20/980	6 4 15895 031369
2174	2430226	110	0,248	●			20/480	6 4 15895 031376

Merika muhvikulmayhteet 88,5°

2124	2449641	32	0,025		●		10	6 4 15824 496412
21241	2449642	32 /pyör.	0,033		●		10	6 4 15824 496429
21242	2449942	32 /pyör.	0,034			●	10	6 4 15824 499420
2134	2449941	32	0,025			●	10	6 4 15824 499413
2176	2430243	50	0,052	●			20/560	6 4 15895 031383
2176V	2449643	50	0,052		●		20/560	6 4 15824 496436
21761	2430343	50 /pyör.	0,052	●			15/420	6 4 15895 154839
21761V	2449648	50 /pyör.	0,052		●		15/420	6 4 15824 496481
2177	2430244	75	0,120	●			15/735	6 4 15895 031390
2175	2430344	75 /pyör.	0,167	●			30/720	6 4 15895 120537
2178	2430246	110	0,281	●			15/360	6 4 15895 031406
2159	2430346	110 /pyör.	0,371	●			13/312	6 4 15895 110149

16 PP-osat ja putket



Quality for HVAC
Technology



Merika haarayhteet 45°

Merika nro	LVI nro	koko	paino	harm.	valk.	krom.	kpl (ltk/lava)	EAN
2151	24-69831	32/32	0,040		●		5	6 415824 698311
2153	24-69851	32/32	0,038			●	5	6 415824 698519
2082	24-50036	50/50	0,083	●			20/840	6 415895 126058
2082V	24-60036	50/50	0,083		●		20/840	6 415895 150060
2179	24-50040	75/75	0,187	●			20/480	6 415895 031413
2180	24-50046	110/75	0,333	●			15/300	6 415895 031420
2181	24-50048	110/110	0,475	●			10/200	6 415895 031437

Merika haarayhteet 88,5°

2150	24-69841	32/32	0,036		●		5	6 415824 698410
2152	24-69861	32/32	0,036			●	5	6 415824 698618
21851	24-49420	50/50 /jyrkkä	0,072	●			10/700	6 415824 494203
21851V	24-49424	50/50 /jyrkkä	0,072		●		10/700	6 415824 494241
2182	24-50300	75/75 /pyör.	0,151	●			20	6 415895 031444
2183	24-50306	110/75 /pyör.	0,311	●			13/312	6 415895 031451
2184	24-50308	110/110 /pyör.	0,431	●			10/200	6 415895 031468

16 PP-osat ja putket

Quality for HVAC
Technology



Merika muhvihaarayhteet 45°

Merika nro	LVI nro	koko	paino	harm.	valk.	krom.	kpl (ltk/lava)	EAN
2112	2469931	32/32	0,043		●		5	6 4 15824 699318
2142	2469951	32/32	0,045			●	5	6 4 15824 699516
2185	2450436	50/50	0,088	●			20/840	6 4 15895 031475
2185V	2460436	50/50	0,088		●		20/840	6 4 15895 101673
2186	2450440	75/75	0,203	●			20/480	6 4 15895 031482
2187	2450446	110/75	0,370	●			15/300	6 4 15895 031499
2188	2450448	110/110	0,511	●			10/200	6 4 15895 031505

Merika muhvihaarayhteet 88,5°

2111	2469941	32/32	0,038		●		5	6 4 15824 699417
2143	2469961	32/32	0,038			●	5	6 4 15824 699615
21891	2449419	50/50 /jyrkkä	0,0763	●			10/700	6 4 15824 494197
21891V	2449425	50/50 /jyrkkä	0,0763		●		10/700	6 4 15824 494258
2190	2450700	75/75 /pyör.	0,162	●			10	6 4 15895 031529
2191	2450706	110/75 /pyör.	0,354	●			13/312	6 4 15895 031536
2192	2450708	110/110 /pyör.	0,450	●			10/200	6 4 15895 031543

16 PP-osat ja putket

Quality for HVAC
Technology



Merika pistoyhteet

Merika nro	LVI nro	koko	paino	harm.	valk.	krom.	kpl (ltk/lava)	EAN
2116	2480151	32	0,020		●		10	6 415895 061427
2197	2470153	50	0,036	●			20/2000	6 415895 031581
2197V	2449426	50	0,036		●		20/2000	6 415824 494265
2198	2470154	75	0,088	●			25/1225	6 415895 031598
2199	2470156	110	0,193	●			30/720	6 415895 031604

Merika kaksoismuhvit

2118	2489401	32	0,020		●		10	6 415824 894010
2119	2489400	32/28	0,034		●		10	6 415824 894003
2120	2489501	32	0,022			●	10	6 415824 895017
2193	2470163	50	0,037	●			20/2000	6 415895 031550
2193V	2489402	50	0,037		●		20/2000	6 415824 894027
2194	2470164	75	0,090	●			25/1225	6 415895 031567
2195	2470166	110	0,194	●			30/720	6 415895 031574

16 PP-osat ja putket

Quality for HVAC
Technology



Merika supistajat

Merika nro	LVI nro	koko	paino	harm.	valk.	krom.	kpl (ltk/lava)	EAN
21541	2449430	50/32	0,026		●		10	6 438541 000304
21542	2449431	75/32	0,041		●		15	6 438541 000342
2155	2470106	75/50	0,054	●			25/1350	6 415895 031611
2155L	2470766	75/50 lyhyt	0,051	●			20	6 415895 128519
2156	2470112	110/75	0,142	●			30/1080	6 415895 031628
2156L	2470772	110/75 lyhyt	0,102	●			20	6 415895 128502

Merika tulpat

2117	2480221	32	0,007		●		10	6 415895 031222
2001	2357005	50	0,022	●			100/2400	6 415895 031635
2001V	2449645	50	0,023		●		100/2400	6 415824 496450
2002	2357007	75	0,041	●			25/1750	6 415895 031642
2003	2357011	110	0,108	●			20/840	6 415895 031659

Tulppa

Merika nro	LVI nro	koko	paino	kpl	EAN
2004	2357016	160	0,186	20	6 415895 031666
2000		200	0,489	16	

Puhdistustulppa

2007	2356011	110	0,221	30	6 415895 031673
------	---------	-----	-------	----	-----------------

16 PP-osat ja putket

Quality for HVAC
Technology



Puhdistusyhde

Merika nro	LVI nro	koko	paino	kpl	EAN
2009	2355011	110	0,332	10	6 4 15895 031680

Padotusventtiili sululla

3299	3918114	110 täysaukko	1,558	1	6 4 15839 181143
------	---------	------------------	-------	---	------------------

HT-putken pitimet

14081	3226213	50 mm	0,024	25	6 4 15832 262139
14082	3226209	75 mm	0,035	25	6 4 15832 262092
14083	3226211	110 mm	0,056	10	6 4 15832 262115

Asennuskulmapaketti

230032	2449432	32 mm	0,118	1	6 4 38541 000359
--------	---------	-------	-------	---	------------------

- sisältää asennuskulman puolikkaat, 32 mm muhvikulman, 4 ruuvia ja putkipitimen

16 PP-osat ja putket

Quality for HVAC
Technology



16 PP-osat ja putket



Quality for HVAC
Technology



Muhviputki, KEHIKKO			
tuotetiedot	Merika nro	kpl /kehikko	EAN
Muhviputki/PP • DU 32 × 1000 valkoinen • LVI nro 2449427	M6051	10/pss	6 415824 494272
Muhviputki/PP • DU 32 × 1000 musta	M6051M	10/pss	
Muhviputki/PP • DU 32 × 1500 valkoinen • LVI nro 2449428	M6052	10/pss	6 415824 494289
Muhviputki/PP-kopolymeeri • DU 50 × 250 • harmaa	M2410103	20/ltk	6 415895 143734
Muhviputki/PP-kopolymeeri • DU 50 × 500 • harmaa	M2410113	40/ltk	6 415895 143741
Muhviputki/PP-kopolymeeri • DU 50 × 1000 • harmaa	M2410133	20/pss	6 415895 154006
Muhviputki/PP-kopolymeeri • DU 50 × 3000 • harmaa	M2410163	50	6 415895 130086
Muhviputki/PP-kopolymeeri • DU 75 × 250 • harmaa	M2410104	20/ltk	6 415895 154013
Muhviputki/PP-kopolymeeri • DU 75 × 500 • harmaa	M2410114	18/ltk	6 415895 154020
Muhviputki/PP-kopolymeeri • DU 75 × 1000 • harmaa	M2410134	50	6 415895 128731
Muhviputki/PP-kopolymeeri • DU 75 × 2000 • harmaa	M2410154	50	6 415895 128755
Muhviputki/PP-kopolymeeri • DU 75 × 3000 • harmaa	M2410164	50	6 415895 128779
Muhviputki/PP-kopolymeeri • DU 75 × 4000 • harmaa	M2410174	50	6 415895 128816
Muhviputki/PP-kopolymeeri • DU 110 × 250 • harmaa	M2410106	15/ltk	6 415895 154037
Muhviputki/PP-kopolymeeri • DU 110 × 500 • harmaa	M2410116	9/ltk	6 415895 154044
Muhviputki/PP-kopolymeeri • DU 110 × 1000 • harmaa	M2410136	50	6 415895 128748
Muhviputki/PP-kopolymeeri • DU 110 × 2000 • harmaa	M2410156	50	6 415895 128762
Muhviputki/PP-kopolymeeri • DU 110 × 3000 • harmaa	M2410166	50	6 415895 128786
Muhviputki/PP-kopolymeeri • DU 110 × 4000 • harmaa	M2410176	50	6 438541 000007
Muhviputki/PP-kopolymeeri • DU 110 × 6000 • harmaa	M2410196	50	6 415895 128793

16 PP-osat ja putket

Quality for HVAC
Technology



Muhviton putki, KEHIKKO

tuotetiedot	Merika nro	Kpl /kehikko	EAN
Muhviton putki/PP • 32 × 1000 • valkoinen • LVI-nro 2372581	605	10/pss	6 4 15823 725810
Muhviton putki/PP • 32 × 1000 • musta • LVI-nro 2449429	606	10/pss	6 4 15824 494296
Muhviton putki/PP • 32 × 3000 • valkoinen • LVI-nro 2372591	2114	240	6 4 15823 725919
Muhviton putki/PP • DU 50 × 3000 • harmaa	M2410033	50	6 4 15895 128717
Muhviton putki/PP • DU 50 × 3000 • valkoinen	M2420033	50	6 4 15895 128809
Muhviton putki/PP-kopolymeeri • DU 75 × 4000 • harmaa	M2410044	50	6 4 15895 128724
Muhviton putki/PP-kopolymeeri • DU 110 × 4000 • harmaa	M2410046	50	6 4 15895 153993

Muhviputki, PIENKEHIKKO

Muhviputki/PP-kopolymeeri • DU 75 × 1000 • harmaa	M2410134P	26	6 4 15895 128731
Muhviputki/PP-kopolymeeri • DU 75 × 2000 • harmaa	M2410154P	26	6 4 15895 128755
Muhviputki/PP-kopolymeeri • DU 75 × 3000 • harmaa	M2410164P	26	6 4 15895 128779
Muhviputki/PP-kopolymeeri • DU 75 × 4000 • harmaa	M2410174P	26	6 4 15895 128816
Muhviputki/PP-kopolymeeri • DU 110 × 1000 • harmaa	M2410136P	23	6 4 15895 128748
Muhviputki/PP-kopolymeeri • DU 110 × 2000 • harmaa	M2410156P	23	6 4 15895 128762
Muhviputki/PP-kopolymeeri • DU 110 × 3000 • harmaa	M2410166P	23	6 4 15895 128786
Muhviputki/PP-kopolymeeri • DU 110 × 4000 • harmaa	M2410176P	23	6 4 3854 1000007
Muhviputki/PP-kopolymeeri • DU 110 × 6000 • harmaa	M2410196P	23	6 4 15895 128793

Muhviton putki, PIENKEHIKKO

Muhviton putki/PP • 32 × 3000 • valkoinen • LVI-nro: 22372591	2114P	120	6 4 15823 725919
Muhviton putki/PP-kopolymeeri • DU 75 × 4000 • harmaa	M2410044P	26	6 4 15895 128724
Muhviton putki/PP-kopolymeeri • DU 110 × 4000 • harmaa	M2410046P	23	6 4 15895 153993

17 PVC-osat

Quality for HVAC
Technology



MERIKA®



17 PVC-osat

Quality for HVAC
Technology



Puhdistustulppa					
Merika nro	LVI nro	koko	paino	kpl	EAN
2006	2356016	160	0,375		6 415895 038740
2005	2356020	200	0,549		6 415895 038757

Puhdistusyhde					
2010		160	1,212		

17 PVC-osat

Quality for HVAC
Technology



15° kulmayhde –

Merika nro	LVI nro	koko	paino	kpl	EAN
2020	2216016	160	0,520		6 4 15895 038580
2025	2216020	200	1,030		6 4 15895 038597

30° kulmayhde –

2021	2215016	160	0,700		6 4 15895 038603
2026	2215020	200	1,230		6 4 15895 038610

45° kulmayhde –

2022*	2214016	160	0,730		6 4 15895 036760
2027	2214020	200	1,330		6 4 15895 036777

*) HT-PP

88,5° kulmayhde –

2023	2213016	160	0,990		6 4 15895 036746
2028	2213020	200	1,830		6 4 15895 036753

17 PVC-osat

Quality for HVAC
Technology



45° kulmayhde +

Merika nro	LVI nro	koko	paino	kpl	EAN
2037*	2214616	160	0,890		6 4 15895 036708
2042	2214620	200	1,490		6 4 15895 036715

*) HT-PP

88,5° kulmayhde +

2038	2213616	160	1,100		6 4 15895 036722
2043	2213620	200	1,950		6 4 15895 036739

45° T-yhde -

2060	2217016	160 × 110	1,180		6 4 15895 038627
2061	2217017	160 × 160	1,720		6 4 15895 038634
2062	2217021	200 × 160	2,300		6 4 15895 038641
2063	2217022	200 × 200	3,010		6 4 15895 038658

45° T-yhde +

2064	2217516	160 × 110	1,260		6 4 15895 083924
2065	2217517	160 × 160	1,740		6 4 15895 038665
2066	2217521	200 × 160	2,820		6 4 15895 038672
2067		200 × 200	3,260		

88,5° T-yhde +

2080		200 × 200			
------	--	-----------	--	--	--

17 PVC-osat

Quality for HVAC
Technology



Kaksoismuhvi

Merika nro	LVI nro	koko	paino	kpl	EAN
2070	2224016	160	0,550		6 4 15895 038702
2071	2224020	200	1,130		6 4 15895 038719

Pistoyhde

2072	2223016	160	0,530		6 4 15895 038689
2073	2223020	200	1,100		6 4 15895 038696

Supistus

2075	2222016	160-110	0,350		6 4 15895 038726
2076	2222020	200-160	0,830		6 4 15895 038733
2077	2222025	250-200	1,780		6 4 15895 083917

18 Hanakulmarasiat ja tarvikkeet

Quality for HVAC
Technology



MERIKA®



18 Hanakulmarasiat ja tarvikkeet

Quality for HVAC
Technology



STF Tyyppihyväksytty 15/18 mm
PEX-putkelle



Hanakulmarasia Pex-putkille Asennussyvyys 47 mm

Merika nro	LVI nro	koko	paino	kpl (ltk/lava)	EAN
2270	2014161	Pex-liitin 12 mm	0,264	20	6 4 15820 14 1613
2271	2014162	Puserrusliitin 15 mm	0,255	20/1000	6 4 15820 14 1620
22711	2014148	Pex-liitin 15 mm	0,255	20/1000	6 4 15820 14 1484
2242	2014164	Pex-liitin 18 mm	0,281	20	6 4 15820 14 1644

- valusuojatulpalla • suojaPUTKEN pidikkeellä ja tiivisteellä
- messinkiosat koeponnistettu

Hanakulmarasia Asennussyvyys 40 mm

2235	2014157	Puserrusliitin 15 mm	0,245	20	6 4 15820 14 1576
------	---------	----------------------	-------	----	-------------------

- matala malli • valusuojatulpalla • suojaPUTKEN pidikkeellä ja tiivisteellä • messinkiosa koeponnistettu

Kaksoishanakulmarasia Asennussyvyys 47 mm

2274	2014172	Puserrusliitin 15 mm	0,528	10/500	6 4 15820 14 1729
2290	2014174	Pex-liitin 18 mm	0,580	10	6 4 15820 14 1743
2292 holkilla	2014152	Puserrusliitin 15 mm	0,568	10	6 4 15820 14 1521

- rasian välituki irrotettavissa • valusuojatulpalla • suojaPUTKEN pidikkeellä ja tiivisteellä
- messinkiosat koeponnistettu

Kaksoishanakulmarasia Asennussyvyys 40 mm

2238	2014153	Puserrusliitin 15 mm	0,511	10	6 4 15820 14 1538
------	---------	----------------------	-------	----	-------------------

- matala malli • valusuojatulpalla ja vesivaa'alla • suojaPUTKEN pidikkeellä ja tiivisteellä
- messinkiosa koeponnistettu

Hanakulmarasiat 28 mm suojaPUTKELLE

18 Hanakulmarasiat ja tarvikkeet

Quality for HVAC
Technology



STF Tyypihyväksytty 15/18 mm
PEX-putkelle



Mekapex-hanakulmarasia

Merika nro	LVI nro	koko	paino	kpl (Itk/lava)	EAN
2236	2014154	puserrusliitin 15 mm	0,264	20/1000	6 4 15820 14 1545
22361	2014147	Pex-liitin 15 mm	0,281	20	6 4 15820 14 1477
2239	2014159	Pex-liitin 18 mm	0,282	20	6 4 15820 14 1590

Mekafit-hanakulmarasia

22362	2014149	15 mm	0,493	20	6 4 15820 14 1491
-------	---------	-------	-------	----	-------------------

Hanakulmarasian avain

2267	2014191		0,030	10	6 4 15820 14 1910
------	---------	--	-------	----	-------------------

- sopii hanakulmarasian mutterin kiristykseen ja Merika-muovitulpan ½" avaimeksi

Hanakulmarasiat 25–28 mm suoja-putkelle

18 Hanakulmarasiat ja tarvikkeet

Quality for HVAC
Technology

STF Tyyp hyväksytty 15 mm
PEX-putkelle

kiwa

SINCE
1965



MekaPjk-hanakulmarasia

Merika nro	LVI nro	koko	paino	kpl (ltk/lava)	EAN
2237 Push Fit	2014150	15 mm	0,198	12	6 4 15820 141507
22373 puserrusliittimin	2014151	15 mm	0,231	12	6 4 15820 141514

- Hanakulmarasiat 25-28 mm suoja-putkelle

Vesieristyslaippa MekaPjk-ralialle

23071	2013599		0,015	20	6 4 38541 000038
--------------	---------	--	-------	----	------------------

MekaPjk-kierreholkki

22692	2013594		0,019	10	6 4 38541 000014
--------------	---------	--	-------	----	------------------

MekaPjk koepainetulppa R1/2"

22862 1/2" avainkololla, matala	2013597		0,0054	10	6 4 38541 000021
--	---------	--	--------	----	------------------

MekaPjk sisämutterin avain

22371	2014206		0,040	10	6 4 38541 000045
--------------	---------	--	-------	----	------------------

MekaPjk sisäosan vetoavain

22372	2014207		0,081	10	6 4 38541 000052
--------------	---------	--	-------	----	------------------

HK-rasian jyrsin

22681	2014208		0,053	10	6 4 38541 000069
--------------	---------	--	-------	----	------------------

18 Hanakulmarasiat ja tarvikkeet

Quality for HVAC
Technology



MekaPjk välipala

Merika nro	LVI nro	koko	paino	kpl	EAN
23003*		150 mm	0,059		
23004**	2014212	150 mm	0,107		6 438541 000106
23005***	2014213	150 mm	0,134		6 438541 000113

* sis. libelli, ** sis. libelli ja 32 HT-kulma, *** sis. libelli ja 50 HT-kulma

MekaPjk välipalan asennussarja

230041*			0,047		
230051**			0,069		

*sis. 32 HT-kulman, **sis. 50 HT-kulman

MekaPjk suojatulppa

22374	2014214		0,009		6 438541 000120
-------	---------	--	-------	--	-----------------

Sisäkannatin hanakulmarasian holkille

226921	2014210	kulmikas	0,006		6 438541 000083
226922	2014211	pyöreä	0,006		6 438541 000090

Mekafit-monitoimityökalu

22671	2013601		0,013		6 438541 000267
-------	---------	--	-------	--	-----------------

- 15 mm PEX-putken pään viistämiseen
- MekaPjk ja Mekafit sisäosien asennussyvyyden merkitsemiseen
- Pushfit liittimen avaamiseen

18 Hanakulmarasiat ja tarvikkeet

Quality for HVAC
Technology



Hanakulmarasian mutteri, muovia

Merika nro	LVI nro	koko	paino	kpl (ltk/lava)	EAN
2270_03	2014201	25	0,018	60	6 4 15820 142016
2270_033*	2014204	25 sisäkierteellä	0,018		6 4 15820 142047
2270_09	2014202	35	0,019		6 4 15820 142023
2270_10	2014203	50	0,024	40	6 4 15820 142030
2270_11	2014209	95	0,045	25	6 4 38541 000076
2270_12	2014217	35 vuodon ilmaiseva mutteri	0,019		6 4 38541 000472

*) Sopii 22691:n kanssa

Hanakulmarasian holkki

2269	2014195		0,016	10	6 4 15820 141958
22691**	2014205	ulkokierteellä	0,019	10	6 4 15820 142054

***) Sopii 2270_033 kanssa • Estää roiskeveden pääsyn seinän sisälle • ohjaa mahdollisen vuotoveden ulos • tiivisteellä
• Käytä aina hanakulmarasian holkkeja vesivahingon ehkäisemiseksi!

Vesieristyslaippa hanakulmarasialle

2307	2014196		0,015	20	6 4 15820 141965
------	---------	--	-------	----	------------------

Hyväksytyt vedeneristysaineet: katso ajantasaiset tiedot verkkosivuiltamme www.merika.fi

Koepainetulppa muovia R ½"

2286	2014193	½"	0,006	10	6 4 15820 141934
22861	2014194	½" avainkololla	0,0054	10	6 4 15820 141941

• Merika-hanakulmarasian koepainnista varten • O-rengastiiviste

18 Hanakulmarasiat ja tarvikkeet

Quality for HVAC
Technology



Suojaputken jatko tiivisteellä

Merika nro	LVI nro	koko	paino	kpl (Itk/lava)	EAN
2302	2013638	28/28	0,009	10/500	6 4 15820 136381
2309	2013637	25/25	0,009	10/500	6 4 15820 136374

Valusuojatulppa hanakulmarasialle

2301	2014197		0,006	10	6 4 15820 14 1972
2304			0,006	10	
23041	2014215	25 mm	0,006	10	6 4 38541 000137
23042	2014216	35 mm	0,008	10	6 4 38541 000144

PEX-liitin, katkaistu helmi

1872	2014633	½" × 12	0,053	10	6 4 15820 146335
1871	2014635	½" × 15	0,044	10	6 4 15820 146359

PEX-suojaputken taivutuskulma

2200	2014628	28 ja 25	0,209	40	6 4 15820 146281
2200_03	taivutuskulman runko ilman jatko- ja korokepaloja			20/pss	

• pakkaus sisältää 2 kpl 10 mm ja 2 kpl 15 mm korotuslevyjä • korotuslevyt sopivat myös 1- ja 2-os. lämpöpattereille • Huom! Reiät sidontapannalle • taivutuskulman jatkopalat: Merika 2200_04 Radi 40 mm ja Merika 2200_05 Sani 50 mm

18 Hanakulmarasiat ja tarvikkeet

Quality for HVAC
Technology



Asennusmalli

PPT-muuraustuki hanakulmarasialle

Merika nro	LVI nro	koko	paino	kpl	EAN
G7037052	7037024	2-osainen 150 mm	0,877	20	6 4 15870 370247
G7037053	7037025	2-osainen 100 mm	0,763	20	6 4 15870 370254
G7037054	7037026	1-osainen	0,579	20	6 4 15870 370261
20211	7037045	muuraustuen asennusliitin	0,026	1	6 4 38541 000175

Muuraustuki hanakulmarasialle, muovia

2201	7037033	150 mm	0,485	10	6 4 15870 370339
2202	7037034	100 mm	0,431	10	6 4 15870 370346

Merika -muuraustukien mukana toimitetaan 2 kpl asennusliittimiä Merika nro 20211 ja 4 kpl lyöntitulppia

PEX-putkileikkuri

2303	7010404	0-32 mm putkelle	0,181	1	6 4 15870 104040
-------------	---------	------------------	-------	---	------------------

2270 ja 226922

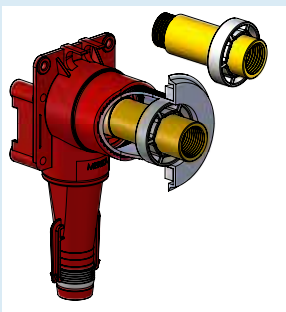

22373 ja 226921

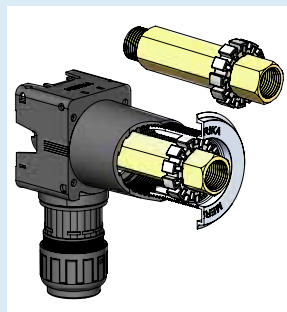

2237 ja 23005

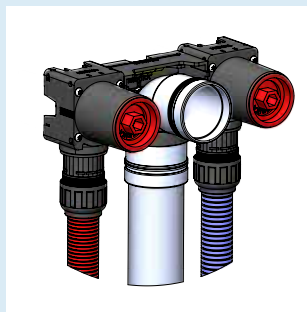

2237 ja 23004

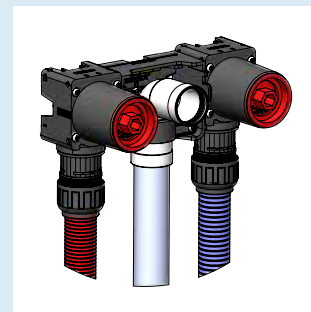

18 Hanakulmarasiat ja tarvikkeet

Quality for HVAC
Technology



Merika 2205



Merika 2206



Merika 2207



Merika 2208



Merika 2209



Suojaputken asennustuki

Merika nro		koko	paino		EAN
2206		8 reikää	0,755		
2209		10 reikää	0,825		
2208		12 reikää	0,934		
2205		16 reikää	1,161		
2207		20 reikää	1,332		

18 Hanakulmarasiat ja tarvikkeet

Quality for HVAC
Technology



MT-holkki Huom! Pitkä malli

Merika nro	LVI nro	koko	paino	kpl	EAN
1921	2013592	12/28	0,013	5	6 4 15820 135926
1922	2013595	15/28	0,013	5/100	6 4 15820 135957
1923	2013598	18/28	0,013	5	6 4 15820 135988
1918		12/28 kromattu	0,014	5	
1919	2013596	15/28 kromattu	0,013	5	6 4 15820 135964
1920		18/28 kromattu	0,013	5	

- käytetään kosteissa tiloissa, pesuhuoneissa, suihkuhuoneissa yms.

K-holkki

1914	2013600	10/28	0,007	20	6 4 15820 136008
1915	2013602	12/28	0,007	20	6 4 15820 136022
1916	2013605	15/28	0,007	20	6 4 15820 136053
1917	2013608	18/28	0,006	20	6 4 15820 136084

Suojaputken suoja PEX-putkelle

19161		25/15	0,0057	10	
19171		28/18	0,0064	10	

18 Hanakulmarasiat ja tarvikkeet

Quality for HVAC
Technology



Suojaputken pidin

Merika nro	LVI nro	koko	paino	kpl	EAN
1400	3226236	24–28	0,003	25	6 4 15832 262368
1396	3226227	25 mm/1-os	0,003	24	6 4 15832 262276
1397	3226228	25 mm/2-os	0,004	24	6 4 15832 262283
1398	3226229	28 mm/1-os	0,004	24	6 4 15832 262290
1399	3226230	28 mm/2-os	0,004	24	6 4 15832 262306

Tukiholkit PEX-muoviputkille Huom! Pitkä malli

16311 muovia		DS 8/12	0,001	100	
16321 muovia	2013593	DS 10/15	0,001	100	6 4 15820 135933
16331 muovia		DS 13/18	0,001	50	

18 Hanakulmarasiat ja tarvikkeet

Quality for HVAC
Technology



Peitelaipat

Merika nro	LVI nro	koko	paino	kpl	EAN
2282 kromattu	6501860	¾" × 90 kork. 25 mm	0,030	2/pss 50 pss/ltk	6 4 15865 018604
2284 kromattu	6501840	½" × 80 kork. 16 mm	0,019	2/pss 50 pss/ltk	6 4 15865 018406
B2282 musta	6501820	¾" × 90 kork. 25 mm	0,030	2/pss 50 pss/ltk	6 4 15865 018208
B2284 musta	6501829	½" × 80 kork. 16 mm	0,019	2/pss 50 pss/ltk	6 4 15865 018291

• ilman kierteitä • myös valkoisena • epäkeskoliittimille

PEX-putken tulppa

16371	2013606	12 mm	0,00053	10	6 4 3854 1000366
16372	2013604	15 mm	0,001	10	6 4 3854 1000373
163721	2013606	16 mm	0,001	10	6 4 3854 1000380
16373	2013607	18 mm	0,002	10	6 4 3854 1000397
163732	2013609	20 mm	0,0025	10	6 4 3854 1000403
16374	2013611	22 mm	0,003	10	6 4 3854 1000410

18 Hanakulmarasiat ja tarvikkeet

Quality for HVAC
Technology



Nordtest-testattu



Jakotukkikaapit ja tarvikkeet

tuotetiedot	Merika nro	LVI nro	paino	EAN
Merikapex-jakotukkikaappi • 550 × 500 × 118 mm	2241	2049502	10,250	6 415820 495020
Jakotukkikaapin ylivuotosetti 28 mm suojaputkelle*	2226	2049543	0,135	6 415820 495433
Jakotukkikaapin ylivuotosetti 25 mm suojaputkelle*	2226/25		0,136	
Kehys jakotukkikaappiin • 550 × 500 × 12 mm	2228	2049522	1,500	6 415820 495228
Kumimuhvi jakotukkikaappiin • 34 mm suojaputkelle • 10 kpl/pss	2243	2049540	0,024	6 415820 495402
Kumimuhvi jakotukkikaappiin • 25 mm suojaputkelle • 10 kpl/pss	22431			
Merikapex asennusmuhvi • 28 mm suojaputkelle	2244	2049541	0,021	6 415820 495419
Merikapex asennusmuhvi • PITKÄ MALLI • 28 mm suojaputkelle	22441	2049547	0,021	6 415820 495471
Merikapex asennusmuhvi • 25 mm suojaputkelle	2224	2049544	0,020	6 415820 495440
Mekapex asennusmuhvi • PITKÄ MALLI • 25/28 suojaputkelle	22211	2049548	0,029	6 415820 495488
Merikapex viemäröintimuhvi • 28 mm suojaputkelle	2245	2049542	0,017	6 415820 495426
Merikapex viemäröintimuhvi • 25 mm suojaputkelle	2225	2049545	0,018	6 415820 495457

*) hanakulmarasian runko, viemäröintimuhvi, vesieristyslaippa, hanakulmarasian holkki, vedenpoiston suojaprikka

18 Hanakulmarasiat ja tarvikkeet

Quality for HVAC
Technology



Nordtest-testattu

Merika 2218



Merika 2219



Merika 2221



Merika 22231



Merika 222312



Merika
222313



Merika 222314



Merika 222315



Jakotukkikaapit ja tarvikkeet

tuotetiedot	Merika nro	LVI nro	paino	EAN
Merika kartiotiiviste 11-21	2218	2049546	0,008	6 415820 495464
Mekapex viemäröintimuhvi 25/28	2219		0,031	
Mekapex asennusmuhvi 25/28	2221		0,029	
Merika Mekapex rasian alaosa 25/28, sis.o-renkaan	2223		0,025	
Merika suojaputken välimuhvi • 10 kpl/pss	22231		0,010	
Mekapex suojaputken jatko 25/28	222312		0,066	
Mekapex suojaputken jatko 28/28	222313		0,040	
Merikapex suojaputken jatko 25/25	222314		0,037	
Merikapex suojaputken jatko 25/28	222315		0,039	

19 Uimuriventtiilit ja WC-varaosat

Quality for HVAC
Technology

SINCE
1965

MERIKA®



19 Uimuriventtiilit ja WC-varaosat

Quality for HVAC
Technology



Uimuriventtiilit					
Merika nro	LVI nro	Sopii WC:t	Paino	kpl	EAN
74035	5733003	31001, 9 litraa	0,374	20	6 4 15857 330035
74034	5733009	31009, 6 litraa	0,369	20	6 4 15857 330097
74080	5733007	Aniara, 6 litraa	0,373	20	6 4 15857 330073
7120	5733011	215, 31002, 9 litraa Teho-ylähuuhtelusäiliöön	0,277	20	6 4 15857 330110

19 Uimuriventtiilit ja WC-varaosat

Quality for HVAC
Technology



WC-korjaussarjat itsepalvelupakkauksessa				
Merika nro	LVI nro	tuotetiedot	Paino	EAN
74002	5733041	Kalvo, neula, kumi, sokka	0,017	6 4 15857 330417
74003	5733043	Uimurivarsi, koho, sokka	0,068	6 4 15857 330431
74004	5733045	Tuloputken liitin 12/10	0,029	6 4 15857 330455
74007	5733031	Pohjaventtiili kiinnitysruuvein	0,108	6 4 15857 330318
74008	5733033	Kumipallo ja kara	0,049	6 4 15857 330332
74018	5733025	Silta, täydellinen, 135 mm	0,055	6 4 15857 330257
74027		Silta, täydellinen, 118 mm	0,057	
74020	5733029	Sulkulevy	0,015	6 4 15857 330295
74021	5733035	Venttiilin kalvo ja neula	0,009	6 4 15857 330356
74023	5733037	Venttiilipesä	0,099	6 4 15857 330370
74028	5733088	Säiliön kiinnitysruuvit (Aniara)	0,091	6 4 15857 330882

19 Uimuriventtiilit ja WC-varaosat

Quality for HVAC
Technology



WC-varaosat				
Merika nro	LVI nro	tuotetiedot	Paino	EAN
73073	5733214	Holkki ja mutteri, messinkiä	0,018	6 4 15857 33214 5
73148		Aluslaatta	0,004	
73149	5733252	Kansimutteri, messinkiä	0,008	6 4 15857 33252 7
73200	5733254	Uimurivarsi, kokonaispituus 214 mm • sopii venttiiliin 74035	0,071	6 4 15857 33254 1
73217	5733272	Uimurivarsi, kokonaispituus 265 mm • sopii venttiiliin 74034	0,067	6 4 15857 33272 5
73286	5733282	Uimurivarsi (Aniara) kokonaispituus 210 mm • sopii venttiiliin 74080	0,066	6 4 15857 33282 4
74009	5733067	Laskuputki	0,035	6 4 15857 33067 7

Jatkuu seuraavalla sivulla

19 Uimuriventtiilit ja WC-varaosat

Quality for HVAC
Technology



WC-varaosat

Merika nro	LVI nro	tuotetiedot	Paino	EAN
71150_01	5733081	Nuppi ruuveineen (64052)	0,008	6 415857 330813
71153_01	5733085	Nuppi ruuveineen (64053)	0,008	6 415857 330851
74040	5733038	Nostolaite, täydellinen, silta 154 mm	0,172	6 415857 330387
74043	5733039	Nostolaite, täydellinen, silta 135 mm	0,175	6 415857 330394
74049	5733073	Sulkuventtiili 1/2 × 10 kr.	0,130	6 415857 330738
74059	5733093	Solumuovitiiviste säiliö/allas • 31001 (63553)	0,020	6 415857 330936
74060	5733091	Solumuovitiiviste säiliö/allas • 31009 (63552)	0,020	6 415857 330912
74061	5733095	Solumuovitiiviste säiliö/allas • 31082 (63554)	0,023	6 415857 330950
74119	5733097	Solumuovitiiviste säiliö/allas Trevi • 31082 (63550)	0,019	6 415857 330974
73119	5733242	Solumuovitiiviste säiliö/pohjaventtiili • Trevi	0,005	6 415857 332428

20 Kunnallistekniset tarvikkeet

Quality for HVAC
Technology



MERIKA®



20 Kunnallistekniset tarvikkeet

Quality for HVAC
Technology



Pallopadotusventtiili

Merika nro	LVI nro	koko	paino	kpl (ltk/lava)	EAN
3300	2623021	110	0,607		6 4 15826 230212

2-muhvinen tarkastushaara, PEH

3201	2606137	110/110	1,150		6 4 15826 061373
3202	2606139	110/200	2,220		6 4 15826 061397

Mansettiiviste teleskooppikansistoja varten

3223	2606171	200/160	0,388		6 4 15826 061717
3222	2606176	400/315	2,480		6 4 15826 061762

Jälkiliittymätiivisteet

3231	2606262	110	0,105	30/2100	6 4 15826 062622
3232	2606263	160	0,144	20/1200	6 4 15826 062639

20 Kunnallistekniset tarvikkeet

Quality for HVAC
Technology



Tarkastushaaran/-kaivon PEH-suojahatut

Merika nro	LVI nro	koko	paino	lisätiedot	kpl (ltk/lava)	EAN
3210	2606151	75	0,026		20/pss	6 415826 061519
3211	2606152	110	0,063		30/1620	6 415826 061526
32111	2606158	110	0,063	rusk., paineviemärille	30	6 415826 061588
3212	2606153	160	0,168		40/1000	6 415826 061533
3213	2606154	200	0,210		20/500	6 415826 061540
3217	2606155	250	0,314		15	6 415826 061557
3214	2606156	315	0,626		10/250	6 415826 061564
32141	2606017	315/250	0,513		15/375	6 415826 060178
3215	2606157	400	1,273		6/120	6 415826 061571
3216	2606159	500	1,951		9/54	6 415826 061595
2913607		110	0,493	kierrekorkki, hitsattava		

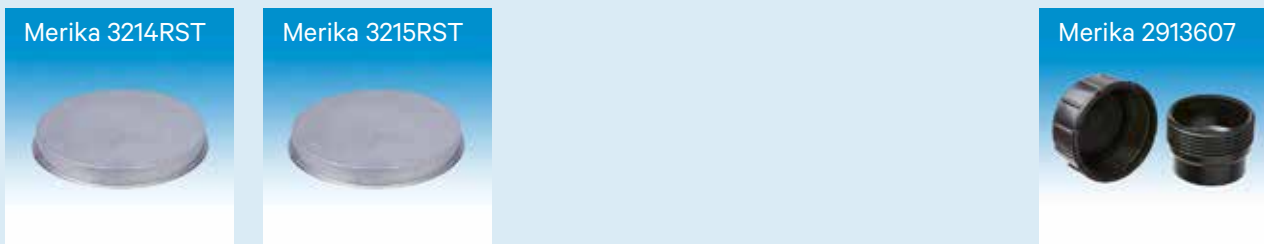

Tarkastushaaran/-kaivon RST-suojahatut

3214RST	2606160	315 × 0,5	0,466		20	6 415826 061601
3215RST	2606161	400 × 0,5	0,730		20	6 415826 061618

20 Kunnallistekniset tarvikkeet

Quality for HVAC
Technology



Täyskorkeat TT-tarkastusputket PEH-muovia

Merika nro	LVI nro	koko	paino	lisätiedot	EAN
1751	2606127	110 × 110/2000	2,880	Sisältää suojahatun	6 4 15826 061274
1752	2606128	110 × 160/2000	5,900	Sisältää suojahatun	6 4 15826 061281
1753	2606129	110 × 200/2000	7,650	Sisältää suojahatun	6 4 15826 061298
1755	Merika-tarkastusputki 110 × 200 – 160/2200 teleskooppi, säätövara 100–580 mm, muovikansistolla, 5 tn				paino 10,900
1756	Merika-tarkastusputki 110 × 200 – 160/2200 teleskooppi, säätövara 100–580 mm, valurautakansistolla, 40 tn				paino 10,900

Hitsattavat PEH-muhvit

3240	2606201	Pitkä 110	0,280		6 4 15826 062011
3256	2606202	Lyhyt 110	0,289		6 4 15826 062028
3257	2606203	160	0,490		6 4 15826 062035
3258	2606204	200	0,990		6 4 15826 062042

20 Kunnallistekniset tarvikkeet

Quality for HVAC
Technology



Jälkiliittymäsatulat, tiivistein ja kiinnitysruuvein

Merika nro	LVI nro	koko	paino	kpl	EAN
32411	2606237	400/110	0,621	40/80	6 4 15826 062370
32421	2606243	400/160	0,880	25/50	6 4 15826 062431
32431	2606244	400/200	1,250	15/30	6 4 15826 062448
32611	2606238	500/110	0,600	40/80	6 4 15826 062387
32612	2606242	500/160	0,885	25/50	6 4 15826 062424
32613	2606239	500/200	1,220	15/30	6 4 15826 062394
32441	2606233	560/110	0,613	15/30	6 4 15826 062332
32451	2606241	560/160	0,885	10/20	6 4 15826 062417
32461	2606240	560/200	1,220	6/12	6 4 15826 062400

20 Kunnallistekniset tarvikkeet

Quality for HVAC
Technology



Teleskoopit ja tiivisteet

Merika nro	LVI nro	koko	paino	kpl	tuotetiedot	EAN
200160	2606023	200/160	0,475	20	Teleskooppirengas huuli- tiivisteellä, pultattava	6 415826 060239
315200	2606024	315/200	0,833	10	Teleskooppirengas huuli- tiivisteellä, pultattava	6 415826 060246
315400	2606025	400/315	1,720	60	Teleskooppirengas huuli- tiivisteellä, pultattava	6 415826 060253
560500	2606028	500/560	3,408		Teleskooppirengas huuli- tiivisteellä, pultattava	6 415826 060284
200160_02		200/180 × 8,0	0,004		Teleskooppirenkaan solu- muovitiiviste	
315200_02		318/290 × 8,0	0,003		Teleskooppirenkaan solu- muovitiiviste	
315400_02		399/338	0,007		Teleskooppirenkaan solu- muovitiiviste	
560500_02		560/500	0,007		Teleskooppirenkaan solu- muovitiiviste	

21 Kansistot

valmistettu Suomessa

Quality for HVAC
Technology



MERIKA®



21 Kansistot

Quality for HVAC
Technology



Kansistot, muovia					
tuotetiedot	Merika nro	LVI nro	paino	kpl /lava	EAN
Merika-muovikansisto umpikannella* • 5 tonnia • 450/315	4132	3364970	3,960	40	6 415833 649700
Merika-muovikansisto alum. ritiläkannella • 3 tonnia • 450/315	41321	3364974	4,255		6 415833 649748
Merika-muovikansisto ritiläkannella • 4 tonnia • 450/315	41322	3364976	3,960	40	6 415833 649762
Merika-muovikansisto umpikannella* • kapea kehys • 5 tonnia • 350/315	4135	3364972	1,822	30	6 415833 649724
Merika-muovikansisto ritiläkannella • 3 tonnia • 350/315	41351	3364977	1,790	30	6 415833 649779
Merika-muovikansisto alumiiniritiläkannella • kapea kehys • 2 tonnia • 350/315	4136	3364973	2,120	10	6 415833 649731
Merika-muovikansisto umpikannella* • 4 tonnia • 340/160/200	4133	3364971	2,040	20	6 415833 649717
Merika-muovikansisto ritiläkannella • 4 tonnia • 340/160/200	41331	3364975	2,040	20	6 415833 649755

*) SFS-EN124 -standardin mukaisia

21 Kansistot

Quality for HVAC
Technology



Kehykset, valurautaa

tuotetiedot	Merika nro	LVI nro	EAN
Merika-valurautakehys • 180	32481	3364911	6 4 15833 649113
Merika-valurautakehys • 315	32482	3364912	6 4 15833 649120
Merika-valurautakehys • 500	32483	3364913	6 4 15833 649137

Kannet, valurautaa

Merika-valurautakansi, ritilä • 180/40 t	32500	3364914	6 4 15833 649144
Merika-valurautakansi, ritilä • 315/40 t	32501	3364915	6 4 15833 649151
Merika-valurautakansi, ritilä • 500/5 t	32502	3364916	6 4 15833 649168
Merika-valurautakansi, umpi • 180/40 t	32511	3364917	6 4 15833 649175
Merika-valurautakansi, umpi • 315/40 t	32512	3364918	6 4 15833 649182
Merika-valurautakansi, umpi • 315/5 t	32513	3364919	6 4 15833 649199

21 Kansistot

Quality for HVAC
Technology



Kansistojen varaosat					
tuotetiedot	Merika nro	LVI nro	paino	kpl /ltk	EAN
Merika kansi 310, alumiini • 2 tonnia	1749	3315775	1,619	1	6 415833 157755
Merika muovikehys 315	443_01	3315791	0,518	1	6 415833 157915
Merika umpikansi 180, muovia • sopii kehukseen 4133_01	4131		0,435		
Merika ritiläkansi 180, muovia • sopii kehukseen 4133_01	41311		0,435		
Merika ritiläkansi 300, muovia • sopii kehyksiin 4132_01 ja 443_01	41312		1,235		
Merika umpikansi 300, muovia • sopii kehukseen 443_01	429		1,300		

22 Mainostuotteet

Quality for HVAC
Technology



MERIKA®



22 Mainostuotteet

Quality for HVAC
Technology



Suppilot, muovia							
tuote	Merika nro	LVI nro	väri	koko	kpl ltk/lava	paino	EAN
Suppilo	2916	7188701	valk.	ø 130		0,039	
Suppilo	2919		musta	ø 130		0,039	

Mainostuotteet							
Kahva	KAHVAH		harm.	pit. 175		0,041	
Kahva	KAHVAM		musta	pit. 175		0,041	
Kahva	KAHVAV		valk.	pit. 175		0,041	
Tarvikelaatikko • mukana toimitetaan 3 kpl väliseiniä SLOOTAH	LOOTAH		harm.	125 × 340 × 80	20	0,268	
Tarvikelaatikko • mukana toimitetaan 3 kpl väliseiniä SLOOTAS	LOOTAS		sin.	125 × 340 × 80	20	0,268	
Kulmasuoja sidonta- laitteelle	KULMAS	9999860	kelt.	lev. 150	35/ 1050	0,256	

22 Mainostuotteet

Quality for HVAC
Technology



Mainostuotteet							
Tuote	Merika nro	LVI nro	Väri	Koko	kpl ltk/lava	Paino	EAN
Osoitelipuke	LIPUKE		kelt.	110 × 175		0,027	
Osoitelipuke, pieni	PLIPUKE		kelt.	50 × 30		0,027	
Avaimenperä • sis. avainlenkin ja nimilapun	AVK		v.kelt.	38 × 72		0,009	
Avaimenperä • sis. avainlenkin ja nimilapun	AVP		v.pun.	38 × 72		0,009	
Tähtinuppi • M8 • MS-insertti	VTÄHTI8		valk.			0,017	
Tähtinuppi • M8 • MS-insertti	MTÄHTI8		musta			0,017	
Turvatulppa • harjateräksille	PROT		pun.	12–28 mm	100/ 5600	0,026	
Merika-lippalakki	LIPPIS						

22 Mainostuotteet

Quality for HVAC
Technology



Mainostuotteet							
Tuote	Merika nro	LVI nro	Väri	Koko	Kpl/ ltk	Paino	EAN
Juomamuki	MUKIK		kelt.	0,25 l	64	0,055	
Juomamuki	MUKIS		sin.	0,25 l	64	0,055	
Juomalasi, kirkas	JUO		-	0,3 l	21	0,127	
Juomalasi, kirkas	JUO1		-	0,5 l	16	0,175	
Viinilasi, kirkas	VIINI		-	0,3 l	16	0,126	

23 Sähkötarvikkeet

Quality for HVAC
Technology



MERIKA®



23 Sähkötarvikkeet

Quality for HVAC
Technology

SINCE
1965



Sähkötarvikkeet

tuotetiedot	Merika nro	kpl (pss/ltk)	paino	Sähkönro	EAN
Kojerasian peitekansi IP20 sileä, valkoinen	PJ100	10/100	0,012	1111900	6 4 100 11 119006
Kojerasian peitekansi IP20 sileä, musta	PJ100M	10/100	0,012	1111904	6 4 100 11 119044
Kojerasian peitekansi IP20 sileä, beige	PJ100B	10/100	0,012	1111902	6 4 100 11 119020
Kojerasian peitekansi IP20 sileä, harmaa	PJ100H	10/100	0,012	1111903	6 4 100 11 119037
JakorAsian kansi IP20 sileä, valkoinen	PJ101	10/100	0,023	1111901	6 4 100 11 119013
JakorAsian kansi IP20 sileä, musta	PJ101M	10/100	0,023	1111907	6 4 100 11 119075
JakorAsian kansi IP20 sileä, beige	PJ101B	10/100	0,023	1111905	6 4 100 11 119051
JakorAsian kansi IP20 sileä, harmaa	PJ101H	10/100	0,023	1111906	6 4 100 11 119068
JakorAsian kansi IP20 valkoinen, matta	PJ101VM	10/100	0,023	1111909	6 4 38541 000168
JakorAsian kansi IP20 musta, matta	PJ101MM	10/100	0,023	1111908	6 4 38541 000151
Sähköputken jatko 20	PJ200	30/ -	0,012	1111910	6 4 38541 000182
Putkipäätte 12 mm	PJ300	100/ -	0,0017	1111911	6 4 38541 000199
Putkipäätte 16 mm	PJ301	100/ -	0,0023	1111912	6 4 38541 000205
Putkipäätte 20 mm	PJ302	100/ -	0,0036	1111913	6 4 38541 000212
Putkipäätte 25 mm	PJ303	25/ -	0,0077	1111914	6 4 38541 000229
Putkipäätte 32 mm	PJ304	15/ -	0,01	1111915	6 4 38541 000236
Sähkökaapelin varoitusnauha 0,05 x 100 mm / 250 m	M6415085		2,067		
Putkikiinnike Japp-pipe M16	PJ400	24/ -	0,003	1313900	6 4 38541 000243
Putkikiinnike Japp-pipe M20	PJ401	24/ -	0,004	1313901	6 4 38541 000250
Kumiprikka 30 x 4,5 x 6	PJ700	250/ -	0,0049		

24 Kuljetusboxit

Quality for HVAC
Technology



MERIKA®



POU9996

2913607CU

Kuljetusboxit putkien kuljettamiseen auton katolla

Merika nro	tuotetiedot	koko	paino
POU9996	Putkiboxi 110 × 3000 • Muita pituuksia tilauksen mukaan	pituus 3 m, ø 110 mm	5,22
2913607CU	Kierrekorkki • hitsattava • 110 mm solmuketjulla		0,517

25 HD-osat

Quality for HVAC
Technology



MERIKA®



25 HD-osat

Quality for HVAC
Technology

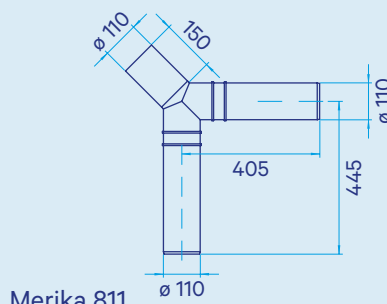

Merika 811

Paisunta-astia kannella halk. 315 mm, kork 470 mm. Muita kokoja tilauksen mukaan

Merika nro	LVI nro	koko	paino	kpl	EAN
920	3401130	30 l	4,970		6 4 15834 011308

HD-jatkot • käyttö-, L- ja rumpuputkille

2103	1829605	63	0,032	50	6 4 15818 296059
2104	1829606	75	0,053	50	6 4 15818 296066
2105	1829607	90		25	6 4 15818 296073
2106	1829608	110	0,165	30	6 4 15818 296080
2107	1829609	140	0,220	10	6 4 15818 296097
2108	1829610	160	0,290	5	6 4 15818 296103
2109	1829612	200	0,633	1	6 4 15818 296127
2110	1829615	315	1,540	1	6 4 15818 296158
2100		400			

Merika-saostuskaivon haarayhde

811	2377511	110	1,090		6 4 15823 775112
-----	---------	-----	-------	--	------------------

26 Reimarit

Quality for HVAC
Technology



MERIKA®

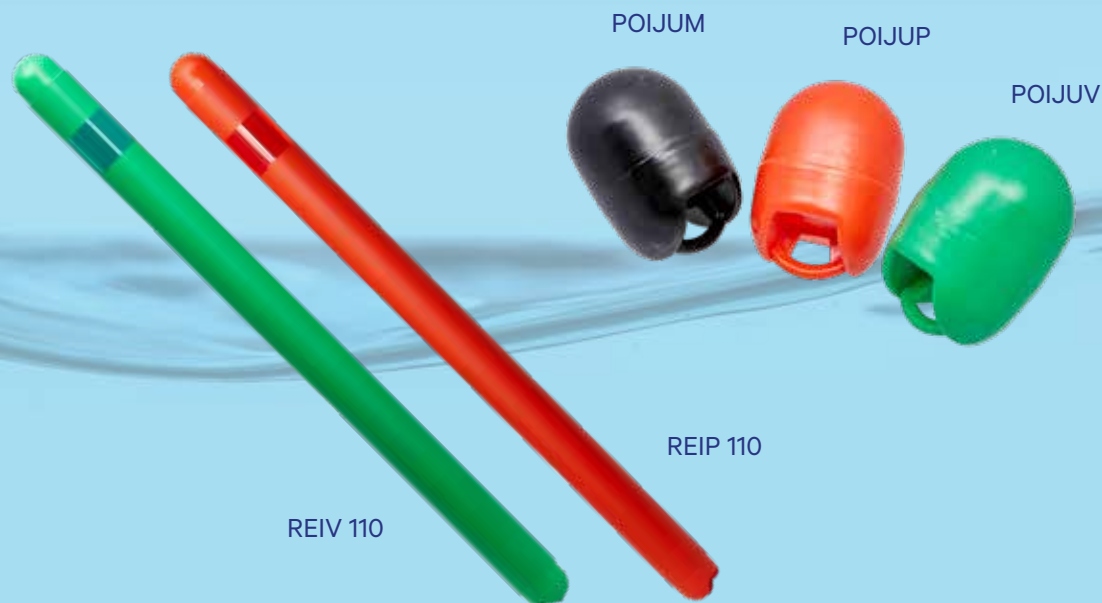

Reimarit

Merika nro	tuotetiedot	paino
REIV 110	Reimari vihreä 110 × 3000 mm	14 kg
REIP 110	Reimari punainen 110 × 3000 mm	14 kg

Sisältää punnuksen • tutkaheijastin • heijastinteippi • sisällä styrox
Tilauksesta myös muita pituuksia. **SAATAVANA MYÖS MUSTANA**

REIV 75	Reimari vihreä 75 × 2000 mm	
REIP 75	Reimari punainen 75 × 2000 mm	

Poijut

POIJUV	Poiju vihreä	0,190 kg
POIJUP	Poiju punainen	0,190 kg
POIJUM	Poiju musta	0,190 kg

27 Muut tuotteet

Quality for HVAC
Technology



MERIKA®



27 Muut tuotteet

Quality for HVAC
Technology



Muut LVI-tuotteet

Merika nro	LVI nro	tuote	EAN
1621	2934092	Vesipostiventtiin avain 8 × 8 muovia	6 415829 340925
1653		Suihkupistooli, supermusta	
1445	2930761	Merika letkuteline, valkoinen	6 415829 307614
1446	2930762	Merika letkuteline, vihreä	6 415829 307621

27 Muut tuotteet

Quality for HVAC
Technology



Kuulasulun pidinpari

Merika nro	LVI nro	tuote	EAN
1644	6500499	Kuulasulun pidinpari	6 415895 083986

Pinta-asennuslevy

1645	6581600	Pinta-asennuslevy 1/2 x 3/4 150 mm, kromattu	6 415865 816002
------	---------	--	-----------------

Messinkitulppa RST-peitelaipalla

1647	6501876	1/2 messinkitulppa/RST peitelaipalla	6 415865 018765
------	---------	--------------------------------------	-----------------

Ilmaruuvien avain

2927	4162054	muovi 5 x 5 • paino 0,003	6 415895 033004
------	---------	---------------------------	-----------------

Poistoputkien korkeudet ja virtaamat Merika-kaivoissa

Quality for HVAC
Technology



Poistoputkien korkeudet ja virtaamat Merika-kaivoissa

Merika nro	koko	tuote	poistoputken keskelle mm	poistoputken päälle mm	virtaama l/s
198	75	Merika 75 mm lattiakaivo korkea malli 32 mm sivuliitännällä	76	39	1,5
199	75	Merika 75 lattiakaivo vaaka 32 mm sivuliitännällä	76	39	1,44
200	75	Merika 75 mm lattiakaivo vaaka 40 mm sivuliitännällä	76	38	1,44
201	75	Merika lattiakaivo matala malli 75 mm, korkeus 119 mm	69	32	0,99
204	50	Merika 75 mm lattiakaivo matala malli, korkeus 119 mm	82	57	0,82
211	75	Merika 75 mm pystykaivo 32 mm sivuliitännällä			0,18
212	75	Merika 75 mm pystykaivo 40 mm sivuliitännällä			2,0
221	32	Merika kuivakaivo 32 mm muhvilla	50	30	0,4
222	40	Merika kuivakaivo 40 mm poistolla	49	29	0,8
2212	32	Merika kuivakaivo 32 mm poistolla	50	32	0,51
310	110	PHV 110/40/500	215	160	
312	110	PVMH 110/40/500, asetuksen 814/2020 mukainen	215	160	
315	110	LKV 110/500	220	165	
321	110	PHV 110/40/400	145	90	
322	110	PHV 110/40/400	145	90	
331	75	PH 7/75	131	93	
332	110	PH 7/110	113	58	
333	75	PH 30/75	117	79	
334	110	PH 30/110	135	80	
341	75	PHV 7/75	131	93	
342	75	PHV 30/75	117	79	
343	75	PHVS 30/75	94	57	
351	110	PHV 7/110	113	58	
352	110	PHV 30/110	135	80	
353	110	PHVS 30/110	112	57	
359	75	PHS 7/75	131	93	
360	110	PHS 7/110	113	58	
361	75	PHVS 7/75	131	93	
362	110	PHVS 7/110	113	58	
1795	110	SO-K 110/315	268	323	

Tuotehakemisto

Merika-numeron mukaan

Quality for HVAC
Technology



Merika-nro	LVI-nro	Sivu			
100	4162744	7	360	3638013	23
107	4162754	7	361	3638003	23
120	2378125	10	362	3638008	23
123	2378123	10	375	3638081	15
124	2378323	10	376	3638083	15
125	2378126	10	400	3318112	16
126	2378127	10	401	3318110	16
127	2378128	10	411	3318115	17
129	2378321	10	412	3318117	16
131	2378307	10	413	3318111	16
132	2378311	10	414	3318155	16
135	2378121	10	415	3318175	17
194	3311450	12	421	3318165	17
195	3311414	14	429		129
196	3311422	18	430		51
197	3311438	18	431	3315711	19
198	3311416	12	432	3315710	19
199	3311443	12	435	3315721	19
200	3311426	12	437	3315733	51
201	3311428	12	438		52
204	3311429	12	440		20
205	3311439	18	441	3319215	20
211	3312413	13	442	3315751	26
212	3311427	13	443	3315765	26
213	3311440	18	443	3315765	30
221	3310431	13	445	3315781	20
222	3311418	13	446	3319285	20
225	3310452	15	448	3319280	20
226	3310453	15	455	3318192	20
227	3310454	15	457	3319671	17
310	3638045	29	458	3319673	17
312	3638040	29	510	5688050	33
315	3638063	25	525	6501810	33
321	3638050	29	527	6501811	33
322	3638004	29	531	5710017	66
327	3319672	24	541	6501802	32
328	3319295	26	542	6501803	32
329	3638698	23	543	6501804	32
331	3638001	22	544	6501805	32
332	3638006	22	545	6501806	32
333	3638022	28	546	6501807	32
334	3638032	28	547	6501808	32
335	3638092	24	548	6501809	32
336	3638096	24	560	6501822	32
337	3638095	24	561	6501823	32
341	3638002	22	562	6501824	32
342	3638020	28	563	6501825	32
343	3638024	28	564	6501826	32
351	3638007	22	565	6501827	32
352	3638030	28	570	6501832	32
353	3638034	28	571	6501833	32
359	3638012	23	572	6501834	32
			573	6501835	32
			574	6501836	32
			575		32
			590	6501873	33
			591	6501874	33
			592	6501875	33
			601	2372334	35
			602	2372434	35
			604	2372580	37
			605	2372581	37
			605	2372581	95
			606	2449429	37
			606	2449429	95
			611	2372444	36
			612	2372454	36
			632	2372234	36
			681	2372530	35
			682	2372531	35
			695	2372540	35
			696	2372541	35
			811	2377511	138
			840	6584051	42
			841	6584052	42
			842	6584053	42
			843	6584054	42
			844	6584056	42
			845	6584058	42
			849	6584290	42
			850	6584291	42
			851	6584292	42
			852	6584293	42
			853	6585810	41
			854	6585820	41
			855	6585851	41
			856	6585861	41
			857	6585811	41
			858	6585812	41
			859	6585813	41
			860	5710026	66
			901	3316801	44
			902	3316802	44
			903	3316803	44
			904	3316804	44
			905	3316805	44
			906	3316806	44
			907	3316807	44
			908	3316808	44
			911	3316893	50
			912	3316881	48
			913	3316898	47
			914	3316897	47
			915	3311420	47
			916	3316888	48
			917	3316895	48

Tuotehakemisto

Merika-numeron mukaan

Quality for HVAC
Technology



918	3316899	48	1126	5758271	65	1408	2373323	73
919	3316894	48	1127	5758281	65	1410	2373313	73
920	3401130	138	1128	5758270	65	1412	3226256	72
950	3316811	46	1131	5688511	65	1413	3226258	72
951	3316812	46	1132	5688512	65	1414	3226260	72
952	3316813	46	1141	5688510	65	1415	3226262	72
953	3316814	46	1201	2375075	68	1416	3226264	72
954	3316815	46	1202	2375107	68	1417	3226266	72
955	3316816	46	1210	2373503	68	1445	2930761	141
956	3316817	46	1211	2373505	68	1446	2930762	141
957	3316818	46	1212	2373507	68	1500	6209581	37
961	3316821	44	1213	2373511	68	1501	6209580	37
962	3316822	44	1214	2373516	68	1509	6209481	37
963	3316823	44	1216	2375110	68	1511	6209483	37
964	3316824	44	1219	2373521	69	1513	6209486	39
965	3316825	44	1220	2373524	69	1514	6209487	39
966	3316826	44	1225		69	1515	2371159	38
967	3316827	44	1231	6502197	59	1516	2371164	38
968	3316828	44	1232	6502198	59	1517	2371162	38
969	3316848	45	1241	6502187	59	1531	3255482	66
970	3316863	45	1242	6502188	59	1532	3255481	66
971	3316866	45	1251	5688601	66	1621	2934092	141
980	3316846	45	1311	5978971	61	1644	6500499	142
981	3316841	45	1312	5978973	61	1645	6581600	142
982	3316842	45	1313	5978975	61	1647	6501876	142
983	3316843	45	1314	5978977	61	1653	2941405	141
984	3316845	45	1315	5978979	61	1700	2606021	76
985	3316844	45	1317	5978980	61	1702	2606027	76
986	3316861	45	1318	5978981	61	1704	2606043	76
987	3316862	45	1321	5688011	66	1705	2606051	76
988	3316865	45	1341	7014402	60	1740	2606058	76
989	3316864	45	1351	3263332	60	1741	2606071	76
990	3316868	45	1352	3263334	60	1742	2606076	76
996	3316867	45	1361	3263342	60	1748	3638094	30
997	3316847	45	1362	3263344	60	1749	3315775	30
1001	2376053	54	1370	3263811	60	1749	3315775	129
1002	2376063	54	1396	3226227	73	1751	2606127	123
1003	2376064	54	1396	3226227	111	1752	2606128	123
1004	2376054	54	1397	3226228	73	1753	2606129	123
1010	2376072	54	1397	3226228	111	1755		123
1011	2376073	54	1398	3226229	73	1756		123
1021	2376074	55	1398	3226229	111	1765	2606102	76
1031	2376075	55	1399	3226230	73	1766	2606103	76
1041	2376081	55	1399	3226230	111	1768	2606081	77
1054	2362131	55	1400	3226236	73	1769	2606357	75
1061	2362133	55	1400	3226236	111	1778	2606048	77
1063	2362135	55	1401	3226204	72	1789	2606033	76
1071	2363012	56	1402	3226206	72	1791	2606067	77
1081	2363014	56	1403	3226208	72	1792	2527422	82
1091	2363283	56	1404	3226210	72	1793	2527432	82
1111	5688504	64	1405	3226212	72	1794	2606356	78
1112	5688506	64	1406	3226214	72	1795	2606311	79
1125	5758261	65	1407	3226216	72	1796	2606354	78

Tuotehakemisto

Merika-numeron mukaan

Quality for HVAC
Technology



1797	2606088	69	2066	2217521	99	2156	2470112	91
1871	2014635	107	2067		99	2157	2430144	85
1872	2014633	107	2070	2224016	100	2158	2430146	85
1914	2013600	110	2071	2224020	100	2159	2430346	87
1915	2013602	110	2072	2223016	100	2160	2430003	84
1916	2031605	110	2073	2223020	100	2161	2430004	84
1917	2013608	110	2075	2222016	100	2162	2430006	84
1918		110	2076	2222020	100	2163	2430013	84
1919	2013596	110	2077	2222025	100	2164	2430014	84
1920		110	2080		99	2165	2430016	84
1921	2013592	110	2082	2450036	88	2166	2430023	85
1922	2013595	110	2100		138	2167	2430024	85
1923	2013598	110	2103	1829605	138	2168	2430026	85
1935	6502834	58	2104	1829606	138	2169	2430043	85
1936		58	2105	1829607	138	2170	2430044	85
1942	6502246	59	2106	1829608	138	2171	2430046	85
1943	5975232	59	2107	1829609	138	2172	2430223	87
1945	5975192	58	2108	1829610	138	2173	2430224	87
1946	5975193	58	2109	1829612	138	2174	2430226	87
1947	5975194	58	2110	1829615	138	2175	2430344	87
1971	3311424	18	2111	2469941	89	2176	2430243	87
1991	3311417	13	2112	2469931	89	2177	2430244	87
1992	3311425	13	2114	2372591	37	2178	2430246	87
1993		13	2114	2372591	95	2179	2450040	88
2000		91	2116	2480151	90	2180	2450046	88
2001	2357005	91	2117	2480221	91	2181	2450048	88
2002	2357007	91	2118	2489401	90	2182	2450300	88
2003	2357011	91	2119	2489400	90	2183	2450306	88
2004	2357016	91	2120	2489501	90	2184	2450308	88
2005	2356020	97	2124	2449641	87	2185	2450436	89
2006	2356016	97	2125	2449621	87	2186	2450440	89
2007	2356011	91	2126	2449611	86	2187	2450446	89
2009	2355011	92	2127	2449601	86	2188	2450448	89
2010		97	2128	2449401	84	2190	2450700	89
2020	2216016	98	2129	2449441	85	2191	2450706	89
2021	2215016	98	2130	2449411	84	2192	2450708	89
2022	2214016	98	2131	6502831	58	2193	2470163	90
2023	2213016	98	2134	2449941	87	2194	2470164	90
2025	2216020	98	2135	2449921	87	2195	2470166	90
2026	2215020	98	2136	2449911	86	2197	2470153	90
2027	2214020	98	2137	2449901	86	2198	2470154	90
2028	2213020	98	2140	2449421	85	2199	2470156	90
2037	2214616	99	2142	2469951	89	2200	2014628	107
2038	2213616	99	2143	2469961	89	2201	7037033	108
2042	2214620	99	2144	2449841	85	2202	7037034	108
2043	2213620	99	2145	2449821	85	2205		109
2051	3311430	18	2146	2449803	84	2206		109
2060	2217016	99	2147	2449801	84	2207		109
2061	2217017	99	2150	2469841	88	2208		109
2062	2217021	99	2151	2469831	88	2209		109
2063	2217022	99	2152	2469861	88	2212	3311433	13
2064	2217516	99	2153	2469851	88	2218	2049546	114
2065	2217517	99	2155	2470106	91	2219		114

Tuotehakemisto

Merika-numeron mukaan

Quality for HVAC
Technology



2221.....	114	3223.....	2606171.....	121	16311.....	2013614.....	111
2223.....	114	3231.....	2606262.....	121	16321.....	2013593.....	111
2224.....	2049544.....	3232.....	2606263.....	121	16331.....	111
2225.....	2049545.....	3240.....	2606201.....	123	16371.....	2013603.....	112
2226.....	2049543.....	3256.....	2606202.....	123	16372.....	2013604.....	112
2228.....	2049522.....	3257.....	2606203.....	123	16373.....	2013607.....	112
2235.....	2014157.....	3258.....	2606204.....	123	16374.....	2013611.....	112
2236.....	2014154.....	3299.....	3918114.....	92	17951.....	2606016.....	79
2237.....	2014150.....	3300.....	2623021.....	121	17952.....	2606006.....	79
2238.....	2014153.....	4011.....	3311431.....	16	17953.....	2606007.....	78
2239.....	2014159.....	4131.....	129	17954.....	2606010.....	79
2241.....	2049502.....	4132.....	3364970.....	127	17955.....	2606011.....	79
2242.....	2014164.....	4133.....	3364971.....	127	17956.....	2606012.....	79
2243.....	2049540.....	4135.....	3364972.....	127	17957.....	2606029.....	79
2244.....	2049541.....	4136.....	3364973.....	127	17958.....	2606312.....	78
2245.....	2049542.....	4371.....	3311419.....	19	19161.....	110
2267.....	2014191.....	4381.....	3316835.....	52	19171.....	110
2269.....	2014195.....	4382.....	3316836.....	52	19411.....	14
2270.....	2014161.....	4383.....	3316837.....	52	20211.....	7037045.....	108
2271.....	2014162.....	4384.....	3316838.....	52	21241.....	2449642.....	87
2274.....	2014172.....	4385.....	3316839.....	52	21242.....	2449942.....	87
2282.....	6501860.....	4386.....	3316840.....	52	21291.....	2449442.....	85
2284.....	6501840.....	4581.....	3319674.....	17	21292.....	2449842.....	85
2286.....	2014193.....	6111.....	2372335.....	36	21311.....	3312414.....	18
2290.....	2014174.....	6112.....	2372337.....	36	21541.....	2449430.....	91
2292.....	2014152.....	6321.....	2372336.....	36	21542.....	2449431.....	91
2301.....	2014197.....	6322.....	2372338.....	36	21601.....	2430203.....	86
2302.....	2013638.....	6323.....	2372339.....	36	21611.....	2430204.....	86
2303.....	7010404.....	7120.....	5733011.....	116	21621.....	2430206.....	86
2304.....	9161.....	3311415.....	48	21631.....	2430213.....	86
2307.....	2014196.....	9171.....	3316829.....	49	21641.....	2430214.....	86
2309.....	2013637.....	9172.....	3316830.....	49	21651.....	2430216.....	86
2424.....	6502850.....	9173.....	3316831.....	49	21691.....	2430143.....	85
2425.....	6502860.....	9174.....	3316832.....	49	21761.....	2430343.....	87
2444.....	5975171.....	9175.....	3316833.....	49	21851.....	2449420.....	88
2445.....	5975172.....	9176.....	3316834.....	49	21891.....	2449419.....	89
2483.....	6502855.....	9311.....	6584296.....	41	22211.....	2049548.....	113
2484.....	6502880.....	9312.....	6584297.....	41	22231.....	114
2916.....	7188701.....	9313.....	6584298.....	41	22361.....	2014147.....	103
2919.....	9314.....	41	22362.....	2014149.....	103
2922.....	9315.....	6584299.....	41	22371.....	2014206.....	104
2923.....	5975161.....	9316.....	41	22372.....	2014207.....	104
2927.....	4162054.....	10001.....	3226205.....	58	22373.....	2014151.....	104
3201.....	2606137.....	10002.....	3226207.....	58	22374.....	2014214.....	105
3202.....	2606139.....	10311.....	2362132.....	54	22431.....	113
3210.....	2606151.....	11112.....	5758262.....	64	22441.....	2049547.....	113
3211.....	2606152.....	11113.....	5758263.....	64	22671.....	2013601.....	105
3212.....	2606153.....	11114.....	5758264.....	64	22681.....	2014208.....	104
3213.....	2606154.....	11115.....	5758265.....	64	22691.....	2014205.....	106
3214.....	2606156.....	14081.....	3226213.....	92	22692.....	2013594.....	104
3215.....	2606157.....	14082.....	3226209.....	92	22711.....	2014148.....	102
3216.....	2606159.....	14083.....	3226211.....	92	22861.....	2014194.....	106
3217.....	2606155.....	15091.....	6502836.....	39	22862.....	2013597.....	104
3222.....	2606176.....	15092.....	6502835.....	39	23003.....	105

Tuotehakemisto

Merika-numeron mukaan

Quality for HVAC
Technology



23004	2014212	105	74049	5733073	119	132M	2378946	10
23005	2014213	105	74059	5733093	119	135M	2378947	10
23041	2014215	107	74060	5733091	119	1408_03		73
23042	2014216	107	74061	5733095	119	1410_03		73
23071	2013599	104	74080	5733007	116	1436K	3225433	71
32111	2606158	122	74119	5733097	119	14371K	3226217	71
32141	2606017	122	91248		42	1437K	3225434	71
32411	2606237	124	91249		42	1438K	3225435	71
32421	2606243	124	98981	3638071	25	1441K	3225453	71
32431	2606244	124	98982	3638072	25	14421K	3226215	71
32441	2606233	124	111121	5758266	64	1442K	3225454	71
32451	2606241	124	111141	5758268	64	1443K	3225455	71
32461	2606240	124	111151	5758269	64	1509_03	6209488	39
32481	3364911	128	163721	2013606	112	1509_04		39
32482	3364912	128	163732	2013609	112	1509M		37
32483	3364913	128	179561		79	1511M		37
32500	3364914	128	179562		79	1516M	2362134	38
32501	3364915	128	198194	3311452	14	1700M	2606022	76
32502	3364916	128	199194	3311455	14	1760RS	2606361	75
32511	3364917	128	200160	2606023	125	1769/PLUS	2606005	75
32512	3364918	128	211194	3311454	14	1770RS	2606352	75
32513	3364919	128	221194	3311453	14	1778_01	2606049	77
32611	2606238	124	222312		114	1780RS	2606018	75
32612	2606242	124	222313		114	1790RS	2606020	75
32613	2606239	124	222314		114	1795_02		77
41311		129	222315		114	199_05	3311444	19
41312		129	226921	2014210	105	200_01	3319721	20
41321	3364974	127	226922	2014211	105	200-03	3319722	20
41322	3364976	127	230032	2449432	92	200160_02		125
41331	3364975	127	230041		105	2001V	2449645	91
41351	3364977	127	230051		105	202_03	3311447	19
43711	3311437	19	315200	2606024	125	2082V	2460036	88
73073	5733214	118	315400	2606025	125	211_02		18
73119	5733242	119	560500	2606028	125	2114P	2372591	95
73148		118	751000	2378941	9	2155L	2470766	91
73149	5733252	118	751001	2378961	9	2156L	2470772	91
73200	5733254	118	1101000	2378942	9	21601V	2449602	86
73217	5733272	118	1101001	2378962	9	2160V	2449402	84
73286	5733282	118	1601000	2378943	9	21631V	2449612	86
74002	5733041	117	1601001	2378963	9	2163V	2449412	84
74003	5733043	117	2001000	2378944	9	2166V	2449422	85
74004	5733045	117	2001001	2378964	9	21691V	2449647	85
74007	5733031	117	2513127	2527420	82	2169V	2449644	85
74008	5733033	117	2519327	2527421	82	2172V	2449622	87
74009	5733067	118	2913607		122	21761V	2449648	87
74018	5733025	117	100_03		7	2176V	2449643	87
74020	5733029	117	106_03		7	21851V	2449424	88
74021	5733035	117	106_05		7	2185V	2460436	89
74023	5733037	117	107L	4162756	7	21891V	2449425	89
74027		117	1111_02		64	2193V	2489402	90
74028	5733088	117	120M	2378948	10	2197V	2449426	90
74034	5733009	116	123M		10	2200_03		107
74035	5733003	116	125M		10	2226/25		113
74040	5733038	119	126M		10	2270_03	2014201	106
74043	5733039	119	131M	2378945	10	2270_033	2014204	106

Tuotehakemisto

LVI-numeron mukaan

Quality for HVAC
Technology



LVI-nro	Merika-nro	Sivu			
1829605	2103	138	2014204	2270_033	106
1829606	2104	138	2014205	22691	106
1829607	2105	138	2014206	22371	104
1829608	2106	138	2014207	22372	104
1829609	2107	138	2014208	22681	104
1829610	2108	138	2014209	2270_11	106
1829612	2109	138	2014210	226921	105
1829615	2110	138	2014211	226922	105
2013592	1921	110	2014212	23004	105
2013593	16321	111	2014213	23005	105
2013594	22692	104	2014214	22374	105
2013595	1922	110	2014215	23041	107
2013596	1919	110	2014216	23042	107
2013597	22862	104	2014217	2270_12	106
2013598	1923	110	2014628	2200	107
2013599	23071	104	2014633	1872	107
2013600	1914	110	2014635	1871	107
2013601	22671	105	2031605	1916	110
2013602	1915	110	2049502	2241	113
2013603	16371	112	2049522	2228	113
2013604	16372	112	2049540	2243	113
2013606	163721	112	2049541	2244	113
2013607	16373	112	2049542	2245	113
2013608	1917	110	2049543	2226	113
2013609	163732	112	2049544	2224	113
2013611	16374	112	2049545	2225	113
2013614	16311	111	2049546	2218	114
2013637	2309	107	2049547	22441	113
2013638	2302	107	2049548	22211	113
2014147	22361	103	2213016	2023	98
2014148	22711	102	2213020	2028	98
2014149	22362	103	2213616	2038	99
2014150	2237	104	2213620	2043	99
2014151	22373	104	2214016	2022	98
2014152	2292	102	2214020	2027	98
2014153	2238	102	2214616	2037	99
2014154	2236	103	2214620	2042	99
2014157	2235	102	2215016	2021	98
2014159	2239	103	2215020	2026	98
2014161	2270	102	2216016	2020	98
2014162	2271	102	2216020	2025	98
2014164	2242	102	2217016	2060	99
2014172	2274	102	2217017	2061	99
2014174	2290	102	2217021	2062	99
2014191	2267	103	2217022	2063	99
2014193	2286	106	2217516	2064	99
2014194	22861	106	2217517	2065	99
2014195	2269	106	2217521	2066	99
2014196	2307	106	2222016	2075	100
2014197	2301	107	2222020	2076	100
2014201	2270_03	106	2222025	2077	100
2014202	2270_09	106	2223016	2072	100
2014203	2270_10	106	2223020	2073	100
			2224016	2070	100
			2224020	2071	100
			2355011	2009	92
			2356011	2007	91
			2356016	2006	97
			2356020	2005	97
			2357005	2001	91
			2357007	2002	91
			2357011	2003	91
			2357016	2004	91
			2362131	1054	55
			2362132	10311	54
			2362133	1061	55
			2362134	1516M	38
			2362135	1063	55
			2363012	1071	56
			2363014	1081	56
			2363283	1091	56
			2371159	1515	38
			2371162	1517	38
			2371164	1516	38
			2372234	632	36
			2372334	601	35
			2372335	6111	36
			2372336	6321	36
			2372337	6112	36
			2372338	6322	36
			2372339	6323	36
			2372434	602	35
			2372444	611	36
			2372454	612	36
			2372530	681	35
			2372531	682	35
			2372540	695	35
			2372541	696	35
			2372580	604	37
			2372581	605	37
			2372581	605	95
			2372591	2114	37
			2372591	2114	95
			2372591	2114P	95
			2373313	1410	73
			2373323	1408	73
			2373503	1210	68
			2373505	1211	68
			2373507	1212	68
			2373511	1213	68
			2373516	1214	68
			2373521	1219	69
			2373524	1220	69
			2375075	1201	68
			2375107	1202	68
			2375110	1216	68
			2376053	1001	54
			2376054	1004	54

Tuotehakemisto

LVI-numeron mukaan

Quality for HVAC
Technology



2376063	1002	54	2430013	2163	84	2449622	2172V	87
2376064	1003	54	2430014	2164	84	2449641	2124	87
2376072	1010	54	2430016	2165	84	2449642	21241	87
2376073	1011	54	2430023	2166	85	2449643	2176V	87
2376074	1021	55	2430024	2167	85	2449644	2169V	85
2376075	1031	55	2430026	2168	85	2449645	2001V	91
2376081	1041	55	2430043	2169	85	2449647	21691V	85
2377511	811	138	2430044	2170	85	2449648	21761V	87
2378121	135	10	2430046	2171	85	2449801	2147	84
2378123	123	10	2430143	21691	85	2449803	2146	84
2378125	120	10	2430144	2157	85	2449821	2145	85
2378126	125	10	2430146	2158	85	2449841	2144	85
2378127	126	10	2430203	21601	86	2449842	21292	85
2378128	127	10	2430204	21611	86	2449901	2137	86
2378307	131	10	2430206	21621	86	2449911	2136	86
2378311	132	10	2430213	21631	86	2449921	2135	87
2378321	129	10	2430214	21641	86	2449941	2134	87
2378323	124	10	2430216	21651	86	2449942	21242	87
2378941	751000	9	2430223	2172	87	2450036	2082	88
2378942	1101000	9	2430224	2173	87	2450040	2179	88
2378943	1601000	9	2430226	2174	87	2450046	2180	88
2378944	2001000	9	2430243	2176	87	2450048	2181	88
2378945	131M	10	2430244	2177	87	2450300	2182	88
2378946	132M	10	2430246	2178	87	2450306	2183	88
2378947	135M	10	2430343	21761	87	2450308	2184	88
2378948	120M	10	2430344	2175	87	2450436	2185	89
2378961	751001	9	2430346	2159	87	2450440	2186	89
2378962	1101001	9	2449401	2128	84	2450446	2187	89
2378963	1601001	9	2449402	2160V	84	2450448	2188	89
2378964	2001001	9	2449411	2130	84	2450700	2190	89
2410033	M2410033	95	2449412	2163V	84	2450706	2191	89
2410044	M2410044	95	2449419	21891	89	2450708	2192	89
2410046	M2410046	95	2449420	21851	88	2460036	2082V	88
2410103	M2410103	94	2449421	2140	85	2460436	2185V	89
2410104	M2410104	94	2449422	2166V	85	2469831	2151	88
2410106	M2410106	94	2449424	21851V	88	2469841	2150	88
2410113	M2410113	94	2449425	21891V	89	2469851	2153	88
2410114	M2410114	94	2449426	2197V	90	2469861	2152	88
2410116	M2410116	94	2449427	M6051	38	2469931	2112	89
2410133	M2410133	94	2449427	M6051	94	2469941	2111	89
2410134	M2410134	94	2449428	M6052	38	2469951	2142	89
2410136	M2410136	94	2449428	M6052	94	2469961	2143	89
2410154	M2410154	94	2449429	606	37	2470106	2155	91
2410156	M2410156	94	2449429	606	95	2470112	2156	91
2410163	M2410163	94	2449430	21541	91	2470153	2197	90
2410164	M2410164	94	2449431	21542	91	2470154	2198	90
2410166	M2410166	94	2449432	230032	92	2470156	2199	90
2410174	M2410174	94	2449441	2129	85	2470163	2193	90
2410176	M2410176	94	2449442	21291	85	2470164	2194	90
2410196	M2410196	94	2449601	2127	86	2470166	2195	90
2420033	M2420033	95	2449602	21601V	86	2470766	2155L	91
2430003	2160	84	2449611	2126	86	2470772	2156L	91
2430004	2161	84	2449612	21631V	86	2480151	2116	90
2430006	2162	84	2449621	2125	87	2480221	2117	91

Tuotehakemisto

LVI-numeron mukaan

Quality for HVAC
Technology



2489400..... 2119 90	2606155 3217 122	3226217..... 14371K..... 71
2489401..... 2118 90	2606156 3214 122	3226227 1396..... 73
2489402..... 2193V 90	2606157 3215 122	3226227 1396..... 111
2489501..... 2120 90	2606158 32111..... 122	3226228 1397 73
2527420 2513127..... 82	2606159 3216 122	3226228 1397 111
2527421..... 2519327..... 82	2606160 3214RST..... 122	3226229 1398 73
2527422 1792 82	2606161 3215RST..... 122	3226229 1398 111
2527432 1793 82	2606171..... 3223 121	3226230 1399..... 73
2606005 1769/PLUS..... 75	2606176 3222 121	3226230 1399..... 111
2606006 17952..... 79	2606201 3240 123	3226236 1400..... 73
2606007..... 17953..... 78	2606202..... 3256 123	3226236 1400..... 111
2606010..... 17954..... 79	2606203..... 3257 123	3226256 1412 72
2606011 17955..... 79	2606204..... 3258 123	3226258 1413 72
2606012 17956..... 79	2606233..... 32441..... 124	3226260 1414 72
2606016..... 17951 79	2606237 32411 124	3226262 1415 72
2606017 32141 122	2606238..... 32611 124	3226264 1416 72
2606018..... 1780RS 75	2606239..... 32613..... 124	3226266 1417 72
2606020..... 1790RS 75	2606240..... 32461..... 124	3255481 1532 66
2606021..... 1700 76	2606241 32451..... 124	3255482 1531 66
2606022..... 1700M 76	2606242..... 32612..... 124	3263332 1351 60
2606023..... 200160 125	2606243..... 32421..... 124	3263334 1352 60
2606024..... 315200 125	2606244..... 32431..... 124	3263342 1361 60
2606025..... 315400 125	2606262..... 3231 121	3263344 1362 60
2606027..... 1702 76	2606263..... 3232 121	3263811..... 1370 60
2606028..... 560500..... 125	2606311..... 1795 79	3310431..... 221 13
2606029..... 17957..... 79	2606312 17958..... 78	3310452 225 15
2606032..... MP34100 81	2606352..... 1770RS 75	3310453 226 15
2606033..... 1789 76	2606354..... 1796 78	3310454 227 15
2606034..... MP34110..... 81	2606356..... 1794 78	3311414 195 12
2606035..... MP34115..... 81	2606357 1769 75	3311415 9161 48
2606036..... MP34130 81	2606361 1760RS 75	3311416 198 12
2606037..... MP34215..... 81	2623021 3300 121	3311417 1991 13
2606038..... MP34200..... 81	2930761 1445 141	3311418 222 13
2606043..... 1704 76	2930762 1446 141	3311419 4371..... 19
2606048..... 1778 77	2934092..... 1621 141	3311420..... 915 47
2606049 1778_01..... 77	2941405 1653 141	3311421 437_04 51
2606051..... 1705 76	3225433 1436K 71	3311422..... 196 18
2606058..... 1740 76	3225434 1437K..... 71	3311424..... 1971 18
2606059..... PLUS 77	3225435 1438K 71	3311425..... 1992..... 13
2606067..... 1791 77	3225453 1441K..... 71	3311426..... 200..... 12
2606071..... 1741 76	3225454 1442K 71	3311427..... 212 13
2606076..... 1742 76	3225455 1443K 71	3311428..... 201 12
2606081..... 1768 77	3226204 1401 72	3311429..... 204 12
2606088..... 1797 69	3226205 10001..... 58	3311430..... 2051..... 18
2606102..... 1765 76	3226206 1402 72	3311431 4011 16
2606103..... 1766 76	3226207 10002 58	3311433..... 2212 13
2606127 1751 123	3226208 1403 72	3311434..... 437_05 51
2606128 1752 123	3226209 14082..... 92	3311435..... 437_06 51
2606129 1753 123	3226210 1404 72	3311436..... 437_07 51
2606137 3201..... 121	3226211 14083 92	3311437..... 43711 19
2606139 3202..... 121	3226212 1405 72	3311438..... 197 18
2606151..... 3210 122	3226213 14081..... 92	3311439..... 205 18
2606152 3211 122	3226214 1406 72	3311440..... 213 18
2606153 3212 122	3226215 14421K..... 71	3311443..... 199 12
2606154 3213 122	3226216 1407 72	3311444..... 199_05..... 19

Tuotehakemisto

LVI-numeron mukaan

Quality for HVAC
Technology



3311447..... 202_03	19	3316831..... 9173	49	3319673	458.....	17	
3311448..... OR1171X353....	19	3316832	9174.....	49	3319674	4581.....	17
3311449..... OR125X25	19	3316833	9175.....	49	3319721..... 200_01	20	
3311450..... 194	12	3316834	9176.....	49	3319722..... 200-03	20	
3311452..... 198194.....	14	3316835	4381.....	52	3364911..... 32481.....	128	
3311453..... 221194.....	14	3316836	4382.....	52	3364912	32482	128
3311454..... 211194	14	3316837	4383	52	3364913	32483	128
3311455..... 199194.....	14	3316838	4384	52	3364914	32500	128
3312413..... 211.....	13	3316839	4385	52	3364915	32501.....	128
3312414..... 21311.....	18	3316840	4386	52	3364916	32502	128
3312415..... M914	47	3316841..... 981.....	45	3364917	32511	128	
3312416..... M915	47	3316842	982.....	45	3364918	32512.....	128
3312417..... M917	48	3316843	983.....	45	3364919	32513.....	128
3315710..... 432.....	19	3316844	985.....	45	3364970..... 4132.....	127	
3315711	431.....	3316845	984.....	45	3364971	4133.....	127
3315721..... 435.....	19	3316846	980.....	45	3364972..... 4135.....	127	
3315733..... 437.....	51	3316847	997.....	45	3364973..... 4136.....	127	
3315734..... 437_02	51	3316848	969.....	45	3364974..... 41321	127	
3315751..... 442.....	26	3316849	915/32.....	47	3364975..... 41331	127	
3315765..... 443.....	26	3316861..... 986.....	45	3364976..... 41322.....	127		
3315765..... 443.....	30	3316862	987.....	45	3364977..... 41351	127	
3315775..... 1749.....	30	3316863	970.....	45	3401130	920.....	138
3315775..... 1749.....	129	3316864	989.....	45	3638001..... 331	22	
3315781..... 445.....	20	3316865	988.....	45	3638002..... 341	22	
3315791..... 443_01.....	129	3316866	971	45	3638003..... 361	23	
3316801..... 901.....	44	3316867	996.....	45	3638004..... 322.....	29	
3316802	902.....	3316868	990.....	45	3638006..... 332.....	22	
3316803	903.....	3316881..... 912.....	48	3638007..... 351	22		
3316804	904.....	3316882	912/32.....	48	3638008..... 362.....	23	
3316805	905.....	3316888	916.....	48	3638012	359.....	23
3316806	906.....	3316889	911/32	50	3638013	360.....	23
3316807	907.....	3316890	911/50	50	3638020..... 342.....	28	
3316808	908.....	3316893	911.....	50	3638022..... 333.....	28	
3316809	913M	3316894	919.....	48	3638024..... 343.....	28	
3316811..... 950.....	46	3316895	917.....	48	3638030..... 352.....	28	
3316812..... 951.....	46	3316896	914M	47	3638032..... 334.....	28	
3316813..... 952.....	46	3316897	914.....	47	3638034..... 353.....	28	
3316814..... 953.....	46	3316898	913.....	47	3638040..... 312	29	
3316815..... 954.....	46	3316899	918.....	48	3638045..... 310	29	
3316816..... 955.....	46	3318110	401.....	16	3638050..... 321	29	
3316817..... 956.....	46	3318111..... 413	16	3638063..... 315	25		
3316818..... 957.....	46	3318112	400	16	3638071	98981.....	25
3316819..... 915M	47	3318115	411.....	17	3638072..... 98982	25	
3316820	915/32/M	3318117	412	16	3638081..... 375	15	
3316821..... 961.....	44	3318155..... 414.....	16	3638083..... 376.....	15		
3316822	962.....	3318165..... 421.....	17	3638092..... 335.....	24		
3316823	963.....	3318175..... 415.....	17	3638094..... 1748.....	30		
3316824	964.....	3318192..... 455.....	20	3638095..... 337	24		
3316825	965.....	3319215..... 441.....	20	3638096..... 336.....	24		
3316826	966.....	3319280	448.....	20	3638698..... 329.....	23	
3316827..... 967.....	44	3319285	446.....	20	3918114	3299.....	92
3316828	968.....	3319295	328.....	26	4162054	2927.....	142
3316829	9171	3319671..... 457.....	17	4162744	100.....	7	
3316830	9172.....	3319672	327.....	24	4162754	107	7

Tuotehakemisto

LVI-numeron mukaan

Quality for HVAC
Technology



4162756	107L	7	5975192	1945	58	6502835	15092	39
5688011	1321	.66	5975193	1946	58	6502836	15091	39
5688050	510	.33	5975194	1947	58	6502850	2424	62
5688504	1111	.64	5975232	1943	59	6502855	2483	62
5688506	1112	.64	5978971	1311	61	6502860	2425	62
5688510	1141	.65	5978973	1312	61	6502880	2484	62
5688511	1131	.65	5978975	1313	61	6581600	1645	142
5688512	1132	.65	5978977	1314	61	6584051	840	42
5688601	1251	.66	5978979	1315	61	6584052	841	42
5710017	531	.66	5978980	1317	61	6584053	842	42
5710026	860	.66	5978981	1318	61	6584054	843	42
5733003	74035	116	6209481	1509	37	6584056	844	42
5733007	74080	116	6209483	1511	37	6584058	845	42
5733009	74034	116	6209486	1513	39	6584059	840V	42
5733011	7120	116	6209487	1514	39	6584060	841V	42
5733025	74018	117	6209488	1509_03	39	6584061	842V	42
5733029	74020	117	6209580	1501	37	6584062	843V	42
5733031	74007	117	6209581	1500	37	6584290	849	42
5733033	74008	117	6500499	1644	142	6584291	850	42
5733035	74021	117	6501802	541	32	6584292	851	42
5733037	74023	117	6501803	542	32	6584293	852	42
5733038	74040	119	6501804	543	32	6584296	9311	41
5733039	74043	119	6501805	544	32	6584297	9312	41
5733041	74002	117	6501806	545	32	6584298	9313	41
5733043	74003	117	6501807	546	32	6584299	9315	41
5733045	74004	117	6501808	547	32	6585810	853	41
5733067	74009	118	6501809	548	32	6585811	857	41
5733073	74049	119	6501810	525	33	6585812	858	41
5733081	71150_01	119	6501811	527	33	6585813	859	41
5733085	71153_01	119	6501820	B2282	112	6585820	854	41
5733088	74028	117	6501822	560	32	6585851	855	41
5733091	74060	119	6501823	561	32	6585861	856	41
5733093	74059	119	6501824	562	32	7010404	2303	108
5733095	74061	119	6501825	563	32	7014402	1341	60
5733097	74119	119	6501826	564	32	7037024	G7037052	108
5733214	73073	118	6501827	565	32	7037025	G7037053	108
5733242	73119	119	6501829	B2284	112	7037026	G7037054	108
5733252	73149	118	6501832	570	32	7037033	2201	108
5733254	73200	118	6501833	571	32	7037034	2202	108
5733272	73217	118	6501834	572	32	7037045	20211	108
5733282	73286	118	6501835	573	32	7188701	2916	131
5758261	1125	.65	6501836	574	32	9999860	KULMAS	131
5758262	11112	.64	6501840	2284	112		429	129
5758263	11113	.64	6501860	2282	112		430	51
5758264	11114	.64	6501873	590	33		438	52
5758265	11115	.64	6501874	591	33		440	20
5758266	111121	.64	6501875	592	33		575	32
5758268	111141	.64	6501876	1647	142		1225	69
5758269	111151	.64	6502187	1241	59		1755	123
5758270	1128	.65	6502188	1242	59		1756	123
5758271	1126	.65	6502197	1231	59		1918	110
5758281	1127	.65	6502198	1232	59		1920	110
5975161	2923	.62	6502246	1942	59		1936	58
5975171	2444	.59	6502831	2131	58		1993	13
5975172	2445	.59	6502834	1935	58		2000	91

Tuotehakemisto

LVI-numeron mukaan

Quality for HVAC
Technology



..... 2010..... 97 315200_02.... 125 POIJUP..... 139
..... 2067..... 99 315400_02.... 125 POIJUV..... 139
..... 2080..... 99 331_03..... 26 POU9996..... 136
..... 2100..... 138 332_02..... 26 PROT..... 132
..... 2205..... 109 343_01..... 30 PVKM500315.. 80
..... 2206..... 109 430/32..... 51 PVKV500315.. 80
..... 2207..... 109 430/50..... 51 REIP 110..... 139
..... 2208..... 109 430/U..... 51 REIP 75..... 139
..... 2209..... 109 432M..... 19 REIV 110..... 139
..... 2219..... 114 437/32/U..... 51 REIV 75..... 139
..... 2221..... 114 437/32/U/M... 51 SVKM500315.. 80
..... 2223..... 114 437M..... 51 SVKV500315.. 80
..... 2304..... 107 438_02..... 52 VIINI..... 133
..... 2919..... 131 438_03..... 52 VTÄHTI8..... 132
..... 2922..... 62 439_011..... 52 1509M..... 37
..... 4131..... 129 442_01..... 30 1511M..... 37
..... 9314..... 41 560500_02... 125 432M..... 19
..... 9316..... 41 916_01..... 52 M437..... 51
..... 16331..... 111 AVK..... 132 M438..... 52
..... 19161..... 110 AVP..... 132 B1408..... 73
..... 19171..... 110 JUO..... 133 230041..... 105
..... 22231..... 114 JUO1..... 133 230051..... 105
..... 22431..... 113 KAHVAH..... 131 B1242..... 59
..... 23003..... 105 KAHVAM..... 131 19411..... 14
..... 41311..... 129 KAHVAV..... 131 M6052..... 38
..... 41312..... 129 LIPPIS..... 132	
..... 73148..... 118 LIPUKE..... 132	Sähkönrö
..... 74027..... 117 LOOTAH..... 131	Merika-nro
..... 91248..... 42 LOOTAS..... 131	Sivu
..... 91249..... 42 M2410044P... 95	1111900..... PJ100..... 135
..... 179561..... 79 M2410046P... 95	1111901..... PJ101..... 135
..... 179562..... 79 M2410134P... 95	1111902..... PJ100B..... 135
..... 222312..... 114 M2410136P... 95	1111903..... PJ100H..... 135
..... 222313..... 114 M2410154P... 95	1111904..... PJ100M..... 135
..... 222314..... 114 M2410156P... 95	1111905..... PJ101B..... 135
..... 222315..... 114 M2410164P... 95	1111906..... PJ101H..... 135
..... 2913607..... 122 M2410166P... 95	1111907..... PJ101M..... 135
..... 100_03..... 7 M2410174P... 95	1111908..... PJ101MM..... 135
..... 106_03..... 7 M2410176P... 95	1111909..... PJ101VM..... 135
..... 106_05..... 7 M2410196P... 95	1111910..... PJ200..... 135
..... 1111_02..... 64 M34100..... 81	1111911..... PJ300..... 135
..... 123M..... 10 M34110..... 81	1111912..... PJ301..... 135
..... 125M..... 10 M34115..... 81	1111913..... PJ302..... 135
..... 126M..... 10 M34130..... 81	1111914..... PJ303..... 135
..... 1408_03..... 73 M34200..... 81	1111915..... PJ304..... 135
..... 1410_03..... 73 M34215..... 81	1313900..... PJ400..... 135
..... 1509_04..... 39 M6051M..... 38	1313901..... PJ401..... 135
..... 1795_02..... 77 M6051M..... 94 PJ700..... 135
..... 200160_02... 125 MTÄHTI8..... 132 M6415085.... 135
..... 211_02..... 18 MUKIK..... 133	
..... 2200_03..... 107 MUKIS..... 133	
..... 2226/25..... 113 PLIPUKE..... 132	
..... 2913607CU... 136 POIJUM..... 139	

Jos talosi saisi valita...®

Kotimaista laatua LVI- rakentamiseen



Meriser Oy

p. +358 (0)207 189 810
Kauppatie 2
29900 Merikarvia
Finland

Tilaukset 24/7

merika@meriser.fi
www.merika.fi
www.meriser.fi

Meriser Oy:n rekisteröidyt tuotemerkit:

Merika, Pallero, Merika Kuovade, Merika Unipex, Merikatec, Merikanor, Merino, Merika Classic, Merika Elegance, Merika Avantgarde, Muhee, Merika Elviira, Vellu-hanakulma, Aimo-hanakulma, Maija-hanakulma, Meripex, Merikapex, PHVS-kaivo, Merika Hoiax, HK-tiiviste, Mekapex, Merika Snowmould, Merika Snowbox, HK-ovaali, Merika Mekafit, Merika JS, MekaPjk
Jos talosi saisi valita...