

Merika® HT PP-kulmayhde 110 x 45°
Merika nro 2168 ja BK2168

23.08.2022/ PJK
VER 1.1

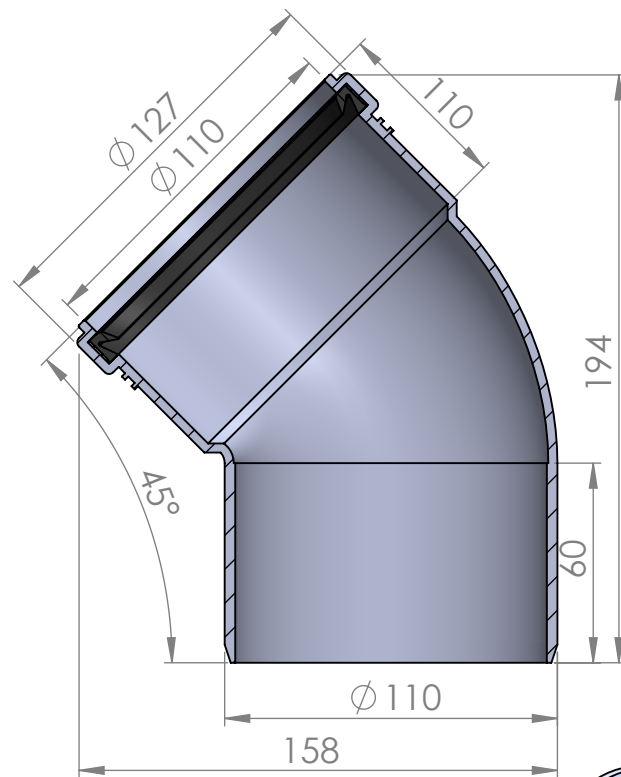

SECTION A-A
SCALE 1 : 2.5

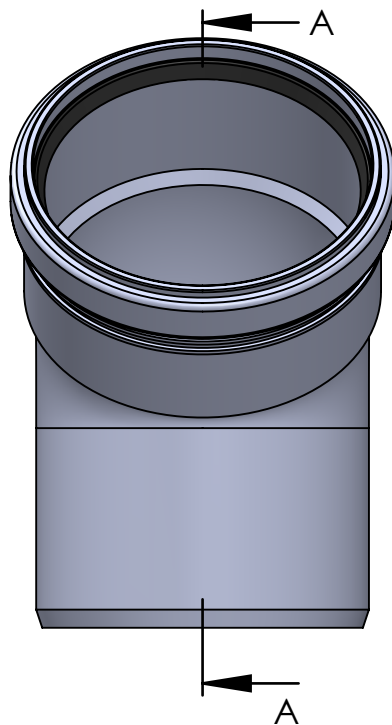
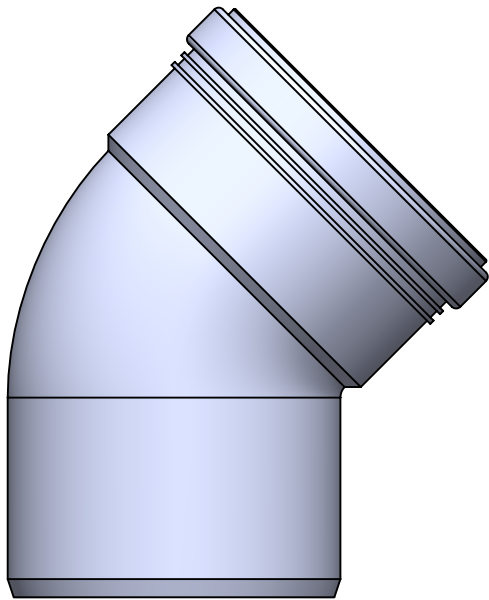