

Merika® Muhvikulmayhde HT-L + 50 x 15
Merika nro 21601 ja 21601V

24.02.2022/ PJK
VER 1.0

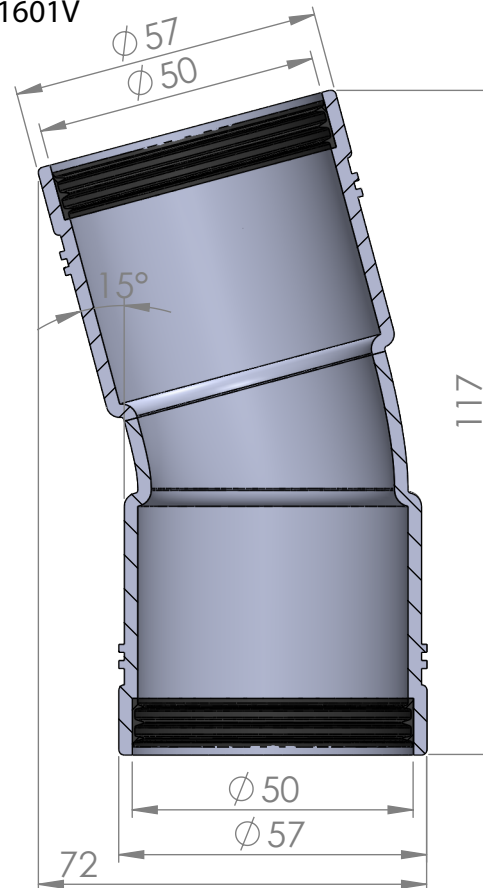

SECTION A-A
SCALE 1 : 1.4

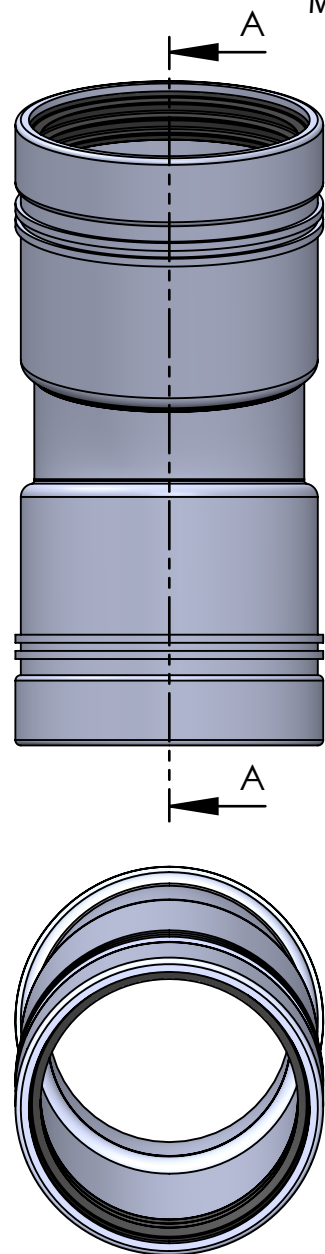