

Merika® Hiekanerotuskaivo  
PH 7/75  
Merika nro 331

17.01.2022/ PJK  
VER 1.0

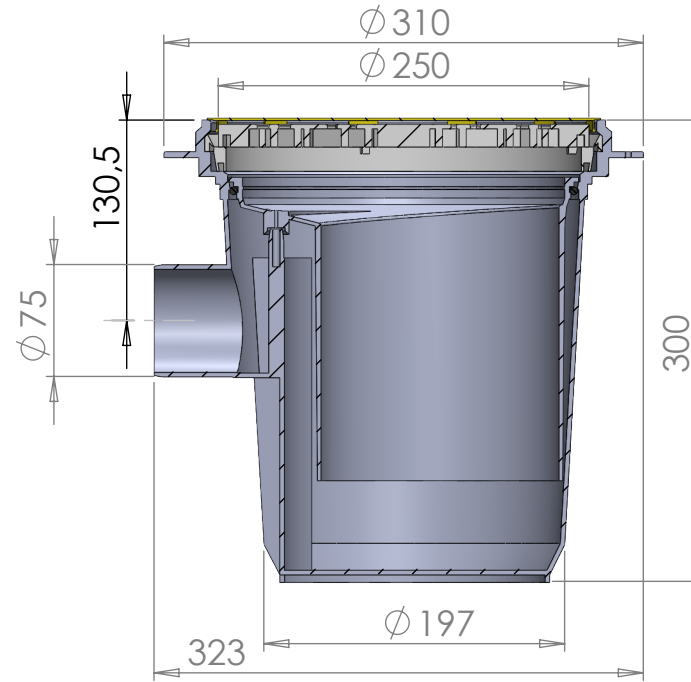

SECTION A-A  
SCALE 1 : 5

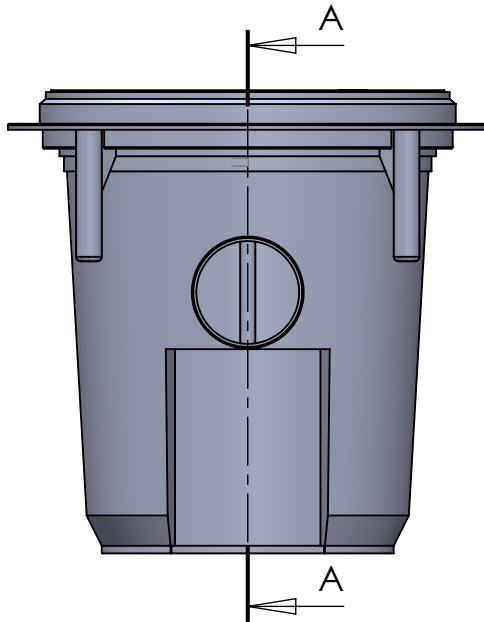