

Merika ® Jälkiliittymäsätula 500/160 tiivistein
Merika nro 32612

26.01.2023/ PJK
VER 1.0

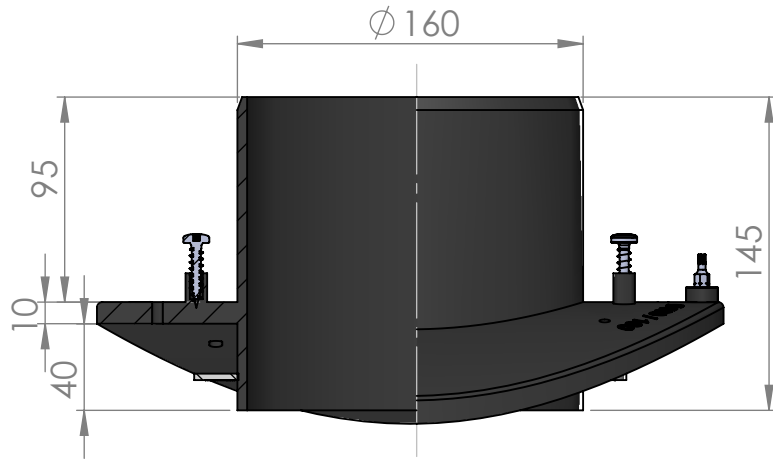

SECTION A-A
SCALE 1 : 3.5

