

Merika® PHV 110 40/400
merika nro 321

18.01.2022/ PJK
VER 1.0

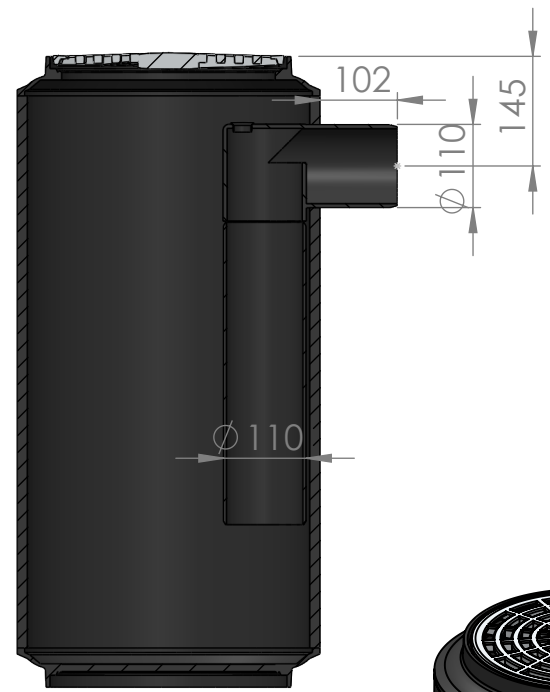

SECTION A-A
SCALE 1 : 10

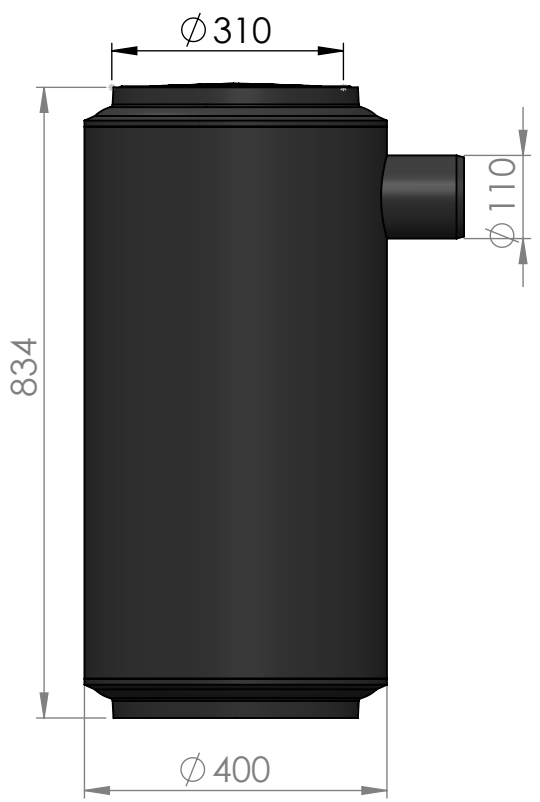