

Merika ® K-holkki 18/28

Merika nro 1917

16.01.2023/ PJK
VER 1.0

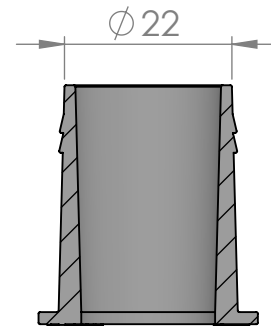
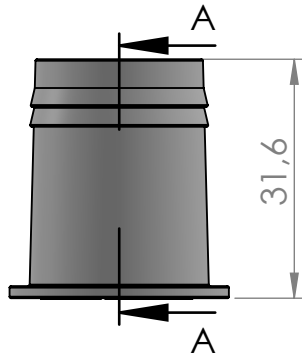
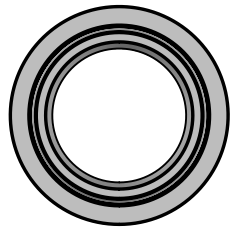

SECTION A-A

