

Merika ® K-holkki 15/28

Merika nro 1916

16.01.2023/ PJK
VER 1.0

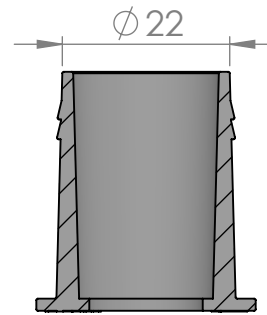
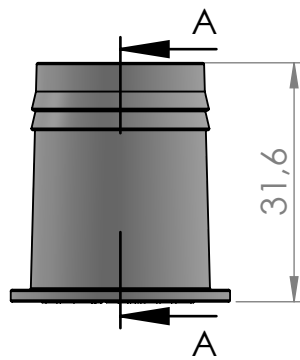
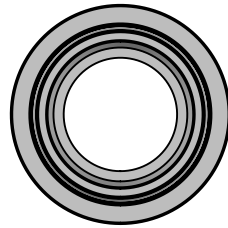

SECTION A-A

